

FM Stereo / RDS

Option for R&S[®]Signal Generators

Operating Manual



1171.6050.12 – 05

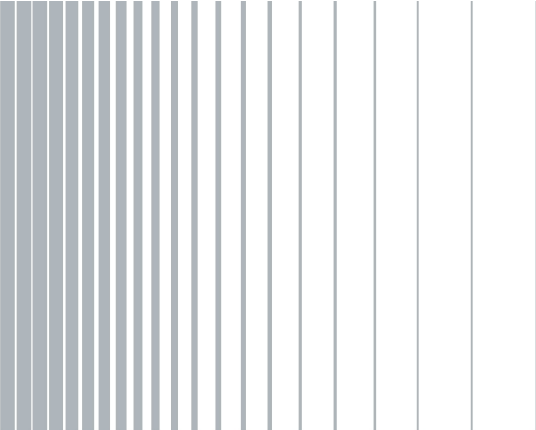

Test & Measurement

Operating Manual

Basic Safety Instructions

Always read through and comply with the following safety instructions!









All plants and locations of the Rohde & Schwarz group of companies make every effort to keep the safety standards of our products up to date and to offer our customers the highest possible degree of safety. Our products and the auxiliary equipment they require are designed, built and tested in accordance with the safety standards that apply in each case. Compliance with these standards is continuously monitored by our quality assurance system. The product described here has been designed, built and tested in accordance with the attached EC Certificate of Conformity and has left the manufacturer's plant in a condition fully complying with safety standards. To maintain this condition and to ensure safe operation, you must observe all instructions and warnings provided in this manual. If you have any questions regarding these safety instructions, the Rohde & Schwarz group of companies will be happy to answer them.







Furthermore, it is your responsibility to use the product in an appropriate manner. This product is designed for use solely in industrial and laboratory environments or, if expressly permitted, also in the field and must not be used in any way that may cause personal injury or property damage. You are responsible if the product is used for any intention other than its designated purpose or in disregard of the manufacturer's instructions. The manufacturer shall assume no responsibility for such use of the product.

The product is used for its designated purpose if it is used in accordance with its product documentation and within its performance limits (see data sheet, documentation, the following safety instructions). Using the product requires technical skills and a basic knowledge of English. It is therefore essential that only skilled and specialized staff or thoroughly trained personnel with the required skills be allowed to use the product. If personal safety gear is required for using Rohde & Schwarz products, this will be indicated at the appropriate place in the product documentation. Keep the basic safety instructions and the product documentation in a safe place and pass them on to the subsequent users.

Observing the safety instructions will help prevent personal injury or damage of any kind caused by dangerous situations. Therefore, carefully read through and adhere to the following safety instructions before and when using the product. It is also absolutely essential to observe the additional safety instructions on personal safety, for example, that appear in relevant parts of the product documentation. In these safety instructions, the word "product" refers to all merchandise sold and distributed by the Rohde & Schwarz group of companies, including instruments, systems and all accessories.





Symbols and safety labels

							
Notice, general danger location Observe product documentation	Caution when handling heavy equipment	Danger of electric shock	Warning! Hot surface	PE terminal	Ground	Ground terminal	Be careful when handling electrostatic sensitive devices

					
ON/OFF supply voltage	Standby indication	Direct current (DC)	Alternating current (AC)	Direct/alternating current (DC/AC)	Device fully protected by double (reinforced) insulation

Tags and their meaning

The following signal words are used in the product documentation in order to warn the reader about risks and dangers.

	indicates a hazardous situation which, if not avoided, will result in death or serious injury.
	indicates a hazardous situation which, if not avoided, could result in death or serious injury.
	indicates a hazardous situation which, if not avoided, could result in minor or moderate injury.
	indicates the possibility of incorrect operation which can result in damage to the product. In the product documentation, the word ATTENTION is used synonymously.

These tags are in accordance with the standard definition for civil applications in the European Economic Area. Definitions that deviate from the standard definition may also exist in other economic areas or military applications. It is therefore essential to make sure that the tags described here are always used only in connection with the related product documentation and the related product. The use of tags in connection with unrelated products or documentation can result in misinterpretation and in personal injury or material damage.

Operating states and operating positions

The product may be operated only under the operating conditions and in the positions specified by the manufacturer, without the product's ventilation being obstructed. If the manufacturer's specifications are not observed, this can result in electric shock, fire and/or serious personal injury or death. Applicable local or national safety regulations and rules for the prevention of accidents must be observed in all work performed.

1. Unless otherwise specified, the following requirements apply to Rohde & Schwarz products: predefined operating position is always with the housing floor facing down, IP protection 2X, pollution severity 2, overvoltage category 2, use only indoors, max. operating altitude 2000 m above sea level, max. transport altitude 4500 m above sea level. A tolerance of $\pm 10\%$ shall apply to the nominal voltage and $\pm 5\%$ to the nominal frequency.
2. Do not place the product on surfaces, vehicles, cabinets or tables that for reasons of weight or stability are unsuitable for this purpose. Always follow the manufacturer's installation instructions when installing the product and fastening it to objects or structures (e.g. walls and shelves). An installation that is not carried out as described in the product documentation could result in personal injury or death.
3. Do not place the product on heat-generating devices such as radiators or fan heaters. The ambient temperature must not exceed the maximum temperature specified in the product documentation or in the data sheet. Product overheating can cause electric shock, fire and/or serious personal injury or death.

Electrical safety

If the information on electrical safety is not observed either at all to the extent necessary, electric shock, fire and/or serious personal injury or death may occur.

1. Prior to switching on the product, always ensure that the nominal voltage setting on the product matches the nominal voltage of the AC supply network. If a different voltage is to be set, the power fuse of the product may have to be changed accordingly.
2. In the case of products of safety class I with movable power cord and connector, operation is permitted only on sockets with an earthing contact and protective earth connection.
3. Intentionally breaking the protective earth connection either in the feed line or in the product itself is not permitted. Doing so can result in the danger of an electric shock from the product. If extension cords or connector strips are implemented, they must be checked on a regular basis to ensure that they are safe to use.
4. If the product does not have a power switch for disconnection from the AC supply network, the plug of the connecting cable is regarded as the disconnecting device. In such cases, always ensure that the power plug is easily reachable and accessible at all times (corresponding to the length of connecting cable, approx. 2 m). Functional or electronic switches are not suitable for providing disconnection from the AC supply network. If products without power switches are integrated into racks or systems, a disconnecting device must be provided at the system level.
5. Never use the product if the power cable is damaged. Check the power cable on a regular basis to ensure that it is in proper operating condition. By taking appropriate safety measures and carefully laying the power cable, you can ensure that the cable will not be damaged and that no one can be hurt by, for example, tripping over the cable or suffering an electric shock.
6. The product may be operated only from TN/TT supply networks fused with max. 16 A (higher fuse only after consulting with the Rohde & Schwarz group of companies).
7. Do not insert the plug into sockets that are dusty or dirty. Insert the plug firmly and all the way into the socket. Otherwise, sparks that result in fire and/or injuries may occur.
8. Do not overload any sockets, extension cords or connector strips; doing so can cause fire or electric shocks.
9. For measurements in circuits with voltages $V_{\text{rms}} > 30 \text{ V}$, suitable measures (e.g. appropriate measuring equipment, fusing, current limiting, electrical separation, insulation) should be taken to avoid any hazards.
10. Ensure that the connections with information technology equipment, e.g. PCs or other industrial computers, comply with the IEC60950-1/EN60950-1 or IEC61010-1/EN 61010-1 standards that apply in each case.
11. Unless expressly permitted, never remove the cover or any part of the housing while the product is in operation. Doing so will expose circuits and components and can lead to injuries, fire or damage to the product.
12. If a product is to be permanently installed, the connection between the PE terminal on site and the product's PE conductor must be made first before any other connection is made. The product may be installed and connected only by a licensed electrician.
13. For permanently installed equipment without built-in fuses, circuit breakers or similar protective devices, the supply circuit must be fused in such a way that anyone who has access to the product, as well as the product itself, is adequately protected from injury or damage.

Basic Safety Instructions

14. Use suitable overvoltage protection to ensure that no overvoltage (such as that caused by a bolt of lightning) can reach the product. Otherwise, the person operating the product will be exposed to the danger of an electric shock.
15. Any object that is not designed to be placed in the openings of the housing must not be used for this purpose. Doing so can cause short circuits inside the product and/or electric shocks, fire or injuries.
16. Unless specified otherwise, products are not liquid-proof (see also section "Operating states and operating positions", item 1. Therefore, the equipment must be protected against penetration by liquids. If the necessary precautions are not taken, the user may suffer electric shock or the product itself may be damaged, which can also lead to personal injury.
17. Never use the product under conditions in which condensation has formed or can form in or on the product, e.g. if the product has been moved from a cold to a warm environment. Penetration by water increases the risk of electric shock.
18. Prior to cleaning the product, disconnect it completely from the power supply (e.g. AC supply network or battery). Use a soft, non-linting cloth to clean the product. Never use chemical cleaning agents such as alcohol, acetone or diluents for cellulose lacquers.

Operation

1. Operating the products requires special training and intense concentration. Make sure that persons who use the products are physically, mentally and emotionally fit enough to do so; otherwise, injuries or material damage may occur. It is the responsibility of the employer/operator to select suitable personnel for operating the products.
2. Before you move or transport the product, read and observe the section titled "Transport".
3. As with all industrially manufactured goods, the use of substances that induce an allergic reaction (allergens) such as nickel cannot be generally excluded. If you develop an allergic reaction (such as a skin rash, frequent sneezing, red eyes or respiratory difficulties) when using a Rohde & Schwarz product, consult a physician immediately to determine the cause and to prevent health problems or stress.
4. Before you start processing the product mechanically and/or thermally, or before you take it apart, be sure to read and pay special attention to the section titled "Waste disposal", item 1.
5. Depending on the function, certain products such as RF radio equipment can produce an elevated level of electromagnetic radiation. Considering that unborn babies require increased protection, pregnant women must be protected by appropriate measures. Persons with pacemakers may also be exposed to risks from electromagnetic radiation. The employer/operator must evaluate workplaces where there is a special risk of exposure to radiation and, if necessary, take measures to avert the potential danger.
6. Should a fire occur, the product may release hazardous substances (gases, fluids, etc.) that can cause health problems. Therefore, suitable measures must be taken, e.g. protective masks and protective clothing must be worn.
7. If a laser product (e.g. a CD/DVD drive) is integrated into a Rohde & Schwarz product, absolutely no other settings or functions may be used as described in the product documentation. The objective is to prevent personal injury (e.g. due to laser beams).

Repair and service

1. The product may be opened only by authorized, specially trained personnel. Before any work is performed on the product or before the product is opened, it must be disconnected from the AC supply network. Otherwise, personnel will be exposed to the risk of an electric shock.
2. Adjustments, replacement of parts, maintenance and repair may be performed only by electrical experts authorized by Rohde & Schwarz. Only original parts may be used for replacing parts relevant to safety (e.g. power switches, power transformers, fuses). A safety test must always be performed after parts relevant to safety have been replaced (visual inspection, PE conductor test, insulation resistance measurement, leakage current measurement, functional test). This helps ensure the continued safety of the product.

Batteries and rechargeable batteries/cells

If the information regarding batteries and rechargeable batteries/cells is not observed either at all or to the extent necessary, product users may be exposed to the risk of explosions, fire and/or serious personal injury, and, in some cases, death. Batteries and rechargeable batteries with alkaline electrolytes (e.g. lithium cells) must be handled in accordance with the EN 62133 standard.

1. Cells must not be taken apart or crushed.
2. Cells or batteries must not be exposed to heat or fire. Storage in direct sunlight must be avoided. Keep cells and batteries clean and dry. Clean soiled connectors using a dry, clean cloth.
3. Cells or batteries must not be short-circuited. Cells or batteries must not be stored in a box or in a drawer where they can short-circuit each other, or where they can be short-circuited by other conductive materials. Cells and batteries must not be removed from their original packaging until they are ready to be used.
4. Keep cells and batteries out of the hands of children. If a cell or a battery has been swallowed, seek medical aid immediately.
5. Cells and batteries must not be exposed to any mechanical shocks that are stronger than permitted.
6. If a cell develops a leak, the fluid must not be allowed to come into contact with the skin or eyes. If contact occurs, wash the affected area with plenty of water and seek medical aid.
7. Improperly replacing or charging cells or batteries that contain alkaline electrolytes (e.g. lithium cells) can cause explosions. Replace cells or batteries only with the matching Rohde & Schwarz type (see parts list) in order to ensure the safety of the product.
8. Cells and batteries must be recycled and kept separate from residual waste. Rechargeable batteries and normal batteries that contain lead, mercury or cadmium are hazardous waste. Observe the national regulations regarding waste disposal and recycling.

Transport

1. The product may be very heavy. Therefore, the product must be handled with care. In some cases, the user may require a suitable means of lifting or moving the product (e.g. with a lift-truck) to avoid back or other physical injuries.

2. Handles on the products are designed exclusively to enable personnel to transport the product. It is therefore not permissible to use handles to fasten the product to or on transport equipment such as cranes, fork lifts, wagons, etc. The user is responsible for securely fastening the products to or on the means of transport or lifting. Observe the safety regulations of the manufacturer of the means of transport or lifting. Noncompliance can result in personal injury or material damage.
3. If you use the product in a vehicle, it is the sole responsibility of the driver to drive the vehicle safely and properly. The manufacturer assumes no responsibility for accidents or collisions. Never use the product in a moving vehicle if doing so could distract the driver of the vehicle. Adequately secure the product in the vehicle to prevent injuries or other damage in the event of an accident.

Waste disposal

1. If products or their components are mechanically and/or thermally processed in a manner that goes beyond their intended use, hazardous substances (heavy-metal dust such as lead, beryllium, nickel) may be released. For this reason, the product may only be disassembled by specially trained personnel. Improper disassembly may be hazardous to your health. National waste disposal regulations must be observed.
2. If handling the product releases hazardous substances or fuels that must be disposed of in a special way, e.g. coolants or engine oils that must be replenished regularly, the safety instructions of the manufacturer of the hazardous substances or fuels and the applicable regional waste disposal regulations must be observed. Also observe the relevant safety instructions in the product documentation. The improper disposal of hazardous substances or fuels can cause health problems and lead to environmental damage.

Informaciones elementales de seguridad

Es imprescindible leer y observar las siguientes instrucciones e informaciones de seguridad!

El principio del grupo de empresas Rohde & Schwarz consiste en tener nuestros productos siempre al día con los estándares de seguridad y de ofrecer a nuestros clientes el máximo grado de seguridad. Nuestros productos y todos los equipos adicionales son siempre fabricados y examinados según las normas de seguridad vigentes. Nuestro sistema de garantía de calidad controla constantemente que sean cumplidas estas normas. El presente producto ha sido fabricado y examinado según el certificado de conformidad adjunto de la UE y ha salido de nuestra planta en estado impecable según los estándares técnicos de seguridad. Para poder preservar este estado y garantizar un funcionamiento libre de peligros, el usuario deberá atenerse a todas las indicaciones, informaciones de seguridad y notas de alerta. El grupo de empresas Rohde & Schwarz está siempre a su disposición en caso de que tengan preguntas referentes a estas informaciones de seguridad.





Además queda en la responsabilidad del usuario utilizar el producto en la forma debida. Este producto está destinado exclusivamente al uso en la industria y el laboratorio o, si ha sido expresamente autorizado, para aplicaciones de campo y de ninguna manera deberá ser utilizado de modo que alguna persona/cosa pueda sufrir daño. El uso del producto fuera de sus fines definidos o sin tener en cuenta las instrucciones del fabricante queda en la responsabilidad del usuario. El fabricante no se hace en ninguna forma responsable de consecuencias a causa del mal uso del producto.







Informaciones elementales de seguridad

Se parte del uso correcto del producto para los fines definidos si el producto es utilizado conforme a las indicaciones de la correspondiente documentación del producto y dentro del margen de rendimiento definido (ver hoja de datos, documentación, informaciones de seguridad que siguen). El uso del producto hace necesarios conocimientos técnicos y ciertos conocimientos del idioma inglés. Por eso se debe tener en cuenta que el producto solo pueda ser operado por personal especializado o personas instruidas en profundidad con las capacidades correspondientes. Si fuera necesaria indumentaria de seguridad para el uso de productos de Rohde & Schwarz, encontraría la información debida en la documentación del producto en el capítulo correspondiente. Guarde bien las informaciones de seguridad elementales, así como la documentación del producto, y entréguelas a usuarios posteriores.

Tener en cuenta las informaciones de seguridad sirve para evitar en lo posible lesiones o daños por peligros de toda clase. Por eso es imprescindible leer detalladamente y comprender por completo las siguientes informaciones de seguridad antes de usar el producto, y respetarlas durante el uso del producto. Deberán tenerse en cuenta todas las demás informaciones de seguridad, como p. ej. las referentes a la protección de personas, que encontrarán en el capítulo correspondiente de la documentación del producto y que también son de obligado cumplimiento. En las presentes informaciones de seguridad se recogen todos los objetos que distribuye el grupo de empresas Rohde & Schwarz bajo la denominación de "producto", entre ellos también aparatos, instalaciones así como toda clase de accesorios.

Símbolos y definiciones de seguridad

							
Aviso: punto de peligro general Observar la documentación del producto	Atención en el manejo de dispositivos de peso elevado	Peligro de choque eléctrico	Advertencia: superficie caliente	Conexión a conductor de protección	Conexión a tierra	Conexión a masa	Aviso: Cuidado en el manejo de dispositivos sensibles a la electrostática (ESD)

					
Tensión de alimentación de PUESTA EN MARCHA / PARADA	Indicación de estado de espera (Standby)	Corriente continua (DC)	Corriente alterna (AC)	Corriente continua / Corriente alterna (DC/AC)	El aparato está protegido en su totalidad por un aislamiento doble (reforzado)

Palabras de señal y su significado

En la documentación del producto se utilizan las siguientes palabras de señal con el fin de advertir contra riesgos y peligros.



PELIGRO identifica un peligro inminente con riesgo elevado que provocará muerte o lesiones graves si no se evita.



ADVERTENCIA identifica un posible peligro con riesgo medio de provocar muerte o lesiones (graves) si no se evita.



ATENCIÓN identifica un peligro con riesgo reducido de provocar lesiones leves o moderadas si no se evita.



AVISO indica la posibilidad de utilizar mal el producto y, como consecuencia, dañarlo.

En la documentación del producto se emplea de forma sinónima el término CUIDADO.

Las palabras de señal corresponden a la definición habitual para aplicaciones civiles en el área económica europea. Pueden existir definiciones diferentes a esta definición en otras áreas económicas o en aplicaciones militares. Por eso se deberá tener en cuenta que las palabras de señal aquí descritas sean utilizadas siempre solamente en combinación con la correspondiente documentación del producto y solamente en combinación con el producto correspondiente. La utilización de las palabras de señal en combinación con productos o documentaciones que no les correspondan puede llevar a interpretaciones equivocadas y tener por consecuencia daños en personas u objetos.

Estados operativos y posiciones de funcionamiento

El producto solamente debe ser utilizado según lo indicado por el fabricante respecto a los estados operativos y posiciones de funcionamiento sin que se obstruya la ventilación. Si no se siguen las indicaciones del fabricante, pueden producirse choques eléctricos, incendios y/o lesiones graves con posible consecuencia de muerte. En todos los trabajos deberán ser tenidas en cuenta las normas nacionales y locales de seguridad del trabajo y de prevención de accidentes.

1. Si no se convino de otra manera, es para los productos Rohde & Schwarz válido lo que sigue: como posición de funcionamiento se define por principio la posición con el suelo de la caja para abajo, modo de protección IP 2X, grado de suciedad 2, categoría de sobrecarga eléctrica 2, uso solamente en estancias interiores, utilización hasta 2000 m sobre el nivel del mar, transporte hasta 4500 m sobre el nivel del mar. Se aplicará una tolerancia de $\pm 10\%$ sobre el voltaje nominal y de $\pm 5\%$ sobre la frecuencia nominal.
2. No sitúe el producto encima de superficies, vehículos, estantes o mesas, que por sus características de peso o de estabilidad no sean aptos para él. Siga siempre las instrucciones de instalación del fabricante cuando instale y asegure el producto en objetos o estructuras (p. ej. paredes y estantes). Si se realiza la instalación de modo distinto al indicado en la documentación del producto, pueden causarse lesiones o incluso la muerte.
3. No ponga el producto sobre aparatos que generen calor (p. ej. radiadores o calefactores). La temperatura ambiente no debe superar la temperatura máxima especificada en la documentación del producto o en la hoja de datos. En caso de sobrecalentamiento del producto, pueden producirse choques eléctricos, incendios y/o lesiones graves con posible consecuencia de muerte.

Seguridad eléctrica

Si no se siguen (o se siguen de modo insuficiente) las indicaciones del fabricante en cuanto a seguridad eléctrica, pueden producirse choques eléctricos, incendios y/o lesiones graves con posible consecuencia de muerte.

1. Antes de la puesta en marcha del producto se deberá comprobar siempre que la tensión preseleccionada en el producto coincida con la de la red de alimentación eléctrica. Si es necesario modificar el ajuste de tensión, también se deberán cambiar en caso dado los fusibles correspondientes del producto.
2. Los productos de la clase de protección I con alimentación móvil y enchufe individual solamente podrán enchufarse a tomas de corriente con contacto de seguridad y con conductor de protección conectado.
3. Queda prohibida la interrupción intencionada del conductor de protección, tanto en la toma de corriente como en el mismo producto. La interrupción puede tener como consecuencia el riesgo de que el producto sea fuente de choques eléctricos. Si se utilizan cables alargadores o regletas de enchufe, deberá garantizarse la realización de un examen regular de los mismos en cuanto a su estado técnico de seguridad.
4. Si el producto no está equipado con un interruptor para desconectarlo de la red, se deberá considerar el enchufe del cable de conexión como interruptor. En estos casos se deberá asegurar que el enchufe siempre sea de fácil acceso (de acuerdo con la longitud del cable de conexión, aproximadamente 2 m). Los interruptores de función o electrónicos no son aptos para el corte de la red eléctrica. Si los productos sin interruptor están integrados en bastidores o instalaciones, se deberá colocar el interruptor en el nivel de la instalación.
5. No utilice nunca el producto si está dañado el cable de conexión a red. Compruebe regularmente el correcto estado de los cables de conexión a red. Asegúrese, mediante las medidas de protección y de instalación adecuadas, de que el cable de conexión a red no pueda ser dañado o de que nadie pueda ser dañado por él, p. ej. al tropezar o por un choque eléctrico.
6. Solamente está permitido el funcionamiento en redes de alimentación TN/TT aseguradas con fusibles de 16 A como máximo (utilización de fusibles de mayor amperaje solo previa consulta con el grupo de empresas Rohde & Schwarz).
7. Nunca conecte el enchufe en tomas de corriente sucias o llenas de polvo. Introduzca el enchufe por completo y fuertemente en la toma de corriente. La no observación de estas medidas puede provocar chispas, fuego y/o lesiones.
8. No sobrecargue las tomas de corriente, los cables alargadores o las regletas de enchufe ya que esto podría causar fuego o choques eléctricos.
9. En las mediciones en circuitos de corriente con una tensión $U_{\text{eff}} > 30 \text{ V}$ se deberán tomar las medidas apropiadas para impedir cualquier peligro (p. ej. medios de medición adecuados, seguros, limitación de tensión, corte protector, aislamiento etc.).
10. Para la conexión con dispositivos informáticos como un PC o un ordenador industrial, debe comprobarse que éstos cumplan los estándares IEC60950-1/EN60950-1 o IEC61010-1/EN 61010-1 válidos en cada caso.
11. A menos que esté permitido expresamente, no retire nunca la tapa ni componentes de la carcasa mientras el producto esté en servicio. Esto pone a descubierto los cables y componentes eléctricos y puede causar lesiones, fuego o daños en el producto.

12. Si un producto se instala en un lugar fijo, se deberá primero conectar el conductor de protección fijo con el conductor de protección del producto antes de hacer cualquier otra conexión. La instalación y la conexión deberán ser efectuadas por un electricista especializado.
13. En el caso de dispositivos fijos que no estén provistos de fusibles, interruptor automático ni otros mecanismos de seguridad similares, el circuito de alimentación debe estar protegido de modo que todas las personas que puedan acceder al producto, así como el producto mismo, estén a salvo de posibles daños.
14. Todo producto debe estar protegido contra sobretensión (debida p. ej. a una caída del rayo) mediante los correspondientes sistemas de protección. Si no, el personal que lo utilice quedará expuesto al peligro de choque eléctrico.
15. No debe introducirse en los orificios de la caja del aparato ningún objeto que no esté destinado a ello. Esto puede producir cortocircuitos en el producto y/o puede causar choques eléctricos, fuego o lesiones.
16. Salvo indicación contraria, los productos no están impermeabilizados (ver también el capítulo "Estados operativos y posiciones de funcionamiento", punto 1). Por eso es necesario tomar las medidas necesarias para evitar la entrada de líquidos. En caso contrario, existe peligro de choque eléctrico para el usuario o de daños en el producto, que también pueden redundar en peligro para las personas.
17. No utilice el producto en condiciones en las que pueda producirse o ya se hayan producido condensaciones sobre el producto o en el interior de éste, como p. ej. al desplazarlo de un lugar frío a otro caliente. La entrada de agua aumenta el riesgo de choque eléctrico.
18. Antes de la limpieza, desconecte por completo el producto de la alimentación de tensión (p. ej. red de alimentación o batería). Realice la limpieza de los aparatos con un paño suave, que no se deshilache. No utilice bajo ningún concepto productos de limpieza químicos como alcohol, acetona o diluyentes para lacas nitrocelulósicas.

Funcionamiento

1. El uso del producto requiere instrucciones especiales y una alta concentración durante el manejo. Debe asegurarse que las personas que manejen el producto estén a la altura de los requerimientos necesarios en cuanto a aptitudes físicas, psíquicas y emocionales, ya que de otra manera no se pueden excluir lesiones o daños de objetos. El empresario u operador es responsable de seleccionar el personal usuario apto para el manejo del producto.
2. Antes de desplazar o transportar el producto, lea y tenga en cuenta el capítulo "Transporte".
3. Como con todo producto de fabricación industrial no puede quedar excluida en general la posibilidad de que se produzcan alergias provocadas por algunos materiales empleados, los llamados alérgenos (p. ej. el níquel). Si durante el manejo de productos Rohde & Schwarz se producen reacciones alérgicas, como p. ej. irritaciones cutáneas, estornudos continuos, enrojecimiento de la conjuntiva o dificultades respiratorias, debe avisarse inmediatamente a un médico para investigar las causas y evitar cualquier molestia o daño a la salud.
4. Antes de la manipulación mecánica y/o térmica o el desmontaje del producto, debe tenerse en cuenta imprescindiblemente el capítulo "Eliminación", punto 1.

5. Ciertos productos, como p. ej. las instalaciones de radiocomunicación RF, pueden a causa de su función natural, emitir una radiación electromagnética aumentada. Deben tomarse todas las medidas necesarias para la protección de las mujeres embarazadas. También las personas con marcapasos pueden correr peligro a causa de la radiación electromagnética. El empresario/operador tiene la obligación de evaluar y señalar las áreas de trabajo en las que exista un riesgo elevado de exposición a radiaciones.
6. Tenga en cuenta que en caso de incendio pueden desprenderse del producto sustancias tóxicas (gases, líquidos etc.) que pueden generar daños a la salud. Por eso, en caso de incendio deben usarse medidas adecuadas, como p. ej. máscaras antigás e indumentaria de protección.
7. En caso de que un producto Rohde & Schwarz contenga un producto láser (p. ej. un lector de CD/DVD), no debe usarse ninguna otra configuración o función aparte de las descritas en la documentación del producto, a fin de evitar lesiones (p. ej. debidas a irradiación láser).

Reparación y mantenimiento

1. El producto solamente debe ser abierto por personal especializado con autorización para ello. Antes de manipular el producto o abrirlo, es obligatorio desconectarlo de la tensión de alimentación, para evitar toda posibilidad de choque eléctrico.
2. El ajuste, el cambio de partes, el mantenimiento y la reparación deberán ser efectuadas solamente por electricistas autorizados por Rohde & Schwarz. Si se reponen partes con importancia para los aspectos de seguridad (p. ej. el enchufe, los transformadores o los fusibles), solamente podrán ser sustituidos por partes originales. Después de cada cambio de partes relevantes para la seguridad deberá realizarse un control de seguridad (control a primera vista, control del conductor de protección, medición de resistencia de aislamiento, medición de la corriente de fuga, control de funcionamiento). Con esto queda garantizada la seguridad del producto.

Baterías y acumuladores o celdas

Si no se siguen (o se siguen de modo insuficiente) las indicaciones en cuanto a las baterías y acumuladores o celdas, pueden producirse explosiones, incendios y/o lesiones graves con posible consecuencia de muerte. El manejo de baterías y acumuladores con electrolitos alcalinos (p. ej. celdas de litio) debe seguir el estándar EN 62133.

1. No deben desmontarse, abrirse ni triturarse las celdas.
2. Las celdas o baterías no deben someterse a calor ni fuego. Debe evitarse el almacenamiento a la luz directa del sol. Las celdas y baterías deben mantenerse limpias y secas. Limpiar las conexiones sucias con un paño seco y limpio.
3. Las celdas o baterías no deben cortocircuitarse. Es peligroso almacenar las celdas o baterías en estuches o cajones en cuyo interior puedan cortocircuitarse por contacto recíproco o por contacto con otros materiales conductores. No deben extraerse las celdas o baterías de sus embalajes originales hasta el momento en que vayan a utilizarse.
4. Mantener baterías y celdas fuera del alcance de los niños. En caso de ingestión de una celda o batería, avisar inmediatamente a un médico.
5. Las celdas o baterías no deben someterse a impactos mecánicos fuertes indebidos.

Informaciones elementales de seguridad

6. En caso de falta de estanqueidad de una celda, el líquido vertido no debe entrar en contacto con la piel ni los ojos. Si se produce contacto, lavar con agua abundante la zona afectada y avisar a un médico.
7. En caso de cambio o recarga inadecuados, las celdas o baterías que contienen electrolitos alcalinos (p. ej. las celdas de litio) pueden explotar. Para garantizar la seguridad del producto, las celdas o baterías solo deben ser sustituidas por el tipo Rohde & Schwarz correspondiente (ver lista de recambios).
8. Las baterías y celdas deben reciclarse y no deben tirarse a la basura doméstica. Las baterías o acumuladores que contienen plomo, mercurio o cadmio deben tratarse como residuos especiales. Respete en esta relación las normas nacionales de eliminación y reciclaje.

Transporte

1. El producto puede tener un peso elevado. Por eso es necesario desplazarlo o transportarlo con precaución y, si es necesario, usando un sistema de elevación adecuado (p. ej. una carretilla elevadora), a fin de evitar lesiones en la espalda u otros daños personales.
2. Las asas instaladas en los productos sirven solamente de ayuda para el transporte del producto por personas. Por eso no está permitido utilizar las asas para la sujeción en o sobre medios de transporte como p. ej. grúas, carretillas elevadoras de horquilla, carros etc. Es responsabilidad suya fijar los productos de manera segura a los medios de transporte o elevación. Para evitar daños personales o daños en el producto, siga las instrucciones de seguridad del fabricante del medio de transporte o elevación utilizado.
3. Si se utiliza el producto dentro de un vehículo, recae de manera exclusiva en el conductor la responsabilidad de conducir el vehículo de manera segura y adecuada. El fabricante no asumirá ninguna responsabilidad por accidentes o colisiones. No utilice nunca el producto dentro de un vehículo en movimiento si esto pudiera distraer al conductor. Asegure el producto dentro del vehículo debidamente para evitar, en caso de un accidente, lesiones u otra clase de daños.

Eliminación

1. Si se trabaja de manera mecánica y/o térmica cualquier producto o componente más allá del funcionamiento previsto, pueden liberarse sustancias peligrosas (polvos con contenido de metales pesados como p. ej. plomo, berilio o níquel). Por eso el producto solo debe ser desmontado por personal especializado con formación adecuada. Un desmontaje inadecuado puede ocasionar daños para la salud. Se deben tener en cuenta las directivas nacionales referentes a la eliminación de residuos.
2. En caso de que durante el trato del producto se formen sustancias peligrosas o combustibles que deban tratarse como residuos especiales (p. ej. refrigerantes o aceites de motor con intervalos de cambio definidos), deben tenerse en cuenta las indicaciones de seguridad del fabricante de dichas sustancias y las normas regionales de eliminación de residuos. Tenga en cuenta también en caso necesario las indicaciones de seguridad especiales contenidas en la documentación del producto. La eliminación incorrecta de sustancias peligrosas o combustibles puede causar daños a la salud o daños al medio ambiente.

Qualitätszertifikat

Certificate of quality

Certificat de qualité

Certified Quality System
ISO 9001

Certified Environmental System
ISO 14001

Sehr geehrter Kunde,

Sie haben sich für den Kauf eines Rohde&Schwarz-Produktes entschieden. Hiermit erhalten Sie ein nach modernsten Fertigungsmethoden hergestelltes Produkt. Es wurde nach den Regeln unseres Qualitätsmanagementsystems entwickelt, gefertigt und geprüft. Das Rohde&Schwarz-Qualitätsmanagementsystem ist u.a. nach ISO9001 und ISO14001 zertifiziert.

Der Umwelt verpflichtet

- ▮ Energie-effiziente, RoHS-konforme Produkte
- ▮ Kontinuierliche Weiterentwicklung nachhaltiger Umweltkonzepte
- ▮ ISO 14001-zertifiziertes Umweltmanagementsystem

Dear Customer,

You have decided to buy a Rohde&Schwarz product. You are thus assured of receiving a product that is manufactured using the most modern methods available. This product was developed, manufactured and tested in compliance with our quality management system standards. The Rohde&Schwarz quality management system is certified according to standards such as ISO9001 and ISO14001.

Environmental commitment

- ▮ Energy-efficient products
- ▮ Continuous improvement in environmental sustainability
- ▮ ISO 14001-certified environmental management system

Cher client,

Vous avez choisi d'acheter un produit Rohde&Schwarz. Vous disposez donc d'un produit fabriqué d'après les méthodes les plus avancées. Le développement, la fabrication et les tests respectent nos normes de gestion qualité. Le système de gestion qualité de Rohde&Schwarz a été homologué, entre autres, conformément aux normes ISO9001 et ISO14001.

Engagement écologique

- ▮ Produits à efficience énergétique
- ▮ Amélioration continue de la durabilité environnementale
- ▮ Système de gestion de l'environnement certifié selon ISO 14001

Customer Support

Technical support – where and when you need it

For quick, expert help with any Rohde & Schwarz equipment, contact one of our Customer Support Centers. A team of highly qualified engineers provides telephone support and will work with you to find a solution to your query on any aspect of the operation, programming or applications of Rohde & Schwarz equipment.

Up-to-date information and upgrades

To keep your instrument up-to-date and to be informed about new application notes related to your instrument, please send an e-mail to the Customer Support Center stating your instrument and your wish. We will take care that you will get the right information.

Europe, Africa, Middle East

Phone +49 89 4129 12345
customersupport@rohde-schwarz.com

North America

Phone 1-888-TEST-RSA (1-888-837-8772)
customer.support@rsa.rohde-schwarz.com

Latin America

Phone +1-410-910-7988
customersupport.la@rohde-schwarz.com

Asia/Pacific

Phone +65 65 13 04 88
customersupport.asia@rohde-schwarz.com

China

Phone +86-800-810-8228 /
+86-400-650-5896
customersupport.china@rohde-schwarz.com



This document describes the following software options:

- R&S®AMU-K57
1403.4102.02
- R&S®SMATE-K57
1400.6450.02
- R&S®SMBV-K57
1415.8190.xx
- R&S®SMJ-K57
1403.6350.02
- R&S®SMU-K57
1403.6250.02

© 2010 Rohde & Schwarz GmbH & Co. KG

Muehldorfstr. 15, 81671 Munich, Germany

Phone: +49 89 41 29 - 0

Fax: +49 89 41 29 12 164

E-mail: info@rohde-schwarz.com

Internet: <http://www.rohde-schwarz.com>

Subject to change – Data without tolerance limits is not binding.

R&S® is a registered trademark of Rohde & Schwarz GmbH & Co. KG.

Trade names are trademarks of the owners.

The following abbreviations are used throughout this manual: R&S®AMU is abbreviated as R&S AMU, R&S®SMATE is abbreviated as R&S SMATE, R&S®SMBV is abbreviated as R&S SMBV, R&S®SMJ is abbreviated as R&S SMJ, R&S®SMU is abbreviated as R&S SMU, R&S®WinIQSIM2 is abbreviated as R&S WinIQSIM2

Contents

1	Preface	5
1.1	Documentation Overview	5
1.2	Typographical Conventions	6
2	Introduction	7
2.1	Modulation System FM-Stereo	7
2.2	Baseband Coding and Group Structure	8
3	FM-Stereo User Interface	12
3.1	Main Settings	12
3.1.1	General Settings	13
3.1.2	Audio Settings	14
3.1.3	Stereo Pilot Tone Settings	18
3.1.4	RDS/RBDS Parameters	18
3.2	RDS/RBDS Configuration	19
3.3	RDS/RBDS Groups Message Settings	21
3.3.1	General Settings	21
3.3.2	Common Settings	21
3.3.3	Group Type 0A .. 15B Settings	23
3.3.4	Group Table	26
3.4	Extended Configuration	27
3.4.1	Group Type 0 - Extended Configuration	27
3.4.2	Group Type 4A - Extended Configuration	29
3.4.3	Group Type 14 - Extended Configuration	31
3.4.3.1	Alternative Frequencies	32
3.4.3.2	Mapped Frequencies	32
3.4.4	Group Type 15 - Extended Configuration	38
3.5	RDS/RBDS User Message Table - Group 0A .. 15B	39
3.6	RDS/RBDS Group Hex Table	40
3.7	Trigger	41
3.7.1	Trigger In	42
3.7.2	Global Settings	42

4 Remote-Control Commands.....43

4.1 Primary Commands.....43

4.2 RDS/RBDS Configurations.....51

4.3 Group Hex Settings.....54

4.4 RDS/RBDS Group Settings.....56

List of Commands.....78

Index.....80

1 Preface

1.1 Documentation Overview

The user documentation for the R&S Signal Generator consists of the following parts:

- Online Help system on the instrument,
- "Quick Start Guide" printed manual,
- Documentation CD-ROM with:
 - Online help system (*.chm) as a standalone help,
 - Operating Manuals for base unit and options,
 - Service Manual,
 - Data sheet and specifications,
 - Links to useful sites on the R&S internet.

Online Help

The Online Help is embedded in the instrument's firmware. It offers quick, context-sensitive access to the complete information needed for operation and programming. The online help contains help on operating the R&S Signal Generator and all available options.

Quick Start Guide

This manual is delivered with the instrument in printed form and in PDF format on the Documentation CD-ROM. It provides the information needed to set up and start working with the instrument. Basic operations and an example of setup are described. The manual includes also general information, e.g., Safety Instructions.

Operating Manuals

The Operating Manuals are a supplement to the Quick Start Guide. Operating Manuals are provided for the base unit and each additional (software) option.

These manuals are available in PDF format - in printable form - on the Documentation CD-ROM delivered with the instrument. In the Operating Manual for the base unit, all instrument functions are described in detail. Furthermore, it provides an introduction to remote control and a complete description of the remote control commands with programming examples. Information on maintenance, instrument interfaces and error messages is also given.

In the individual option manuals, the specific instrument functions of the option are described in detail. For additional information on default settings and parameters, refer to the data sheets. Basic information on operating the R&S Signal Generator is not included in the option manuals.

These manuals can also be ordered in printed form (see ordering information in the data sheet).

Service Manual

This Service Manual is available in PDF format - in printable form - on the Documentation CD-ROM delivered with the instrument. It describes how to check compliance with rated specifications, on instrument function, repair, troubleshooting and fault elimination. It contains all information required for repairing the instrument by the replacement of modules.

This manual can also be orderd in printed form (see ordering information in the data sheet).

Release Notes

The release notes describe new and modified functions, eliminated problems, and last minute changes to the documentation. The corresponding firmware version is indicated on the title page of the release notes. The current release notes are provided in the Internet.

1.2 Typographical Conventions

The following text markers are used throughout this documentation:

Convention	Description
"Graphical user interface elements"	All names of graphical user interface elements on the screen, such as dialog boxes, menus, options, buttons, and softkeys are enclosed by quotation marks.
KEYS	Key names are written in capital letters.
File names, commands, program code	File names, commands, coding samples and screen output are distinguished by their font.
<i>Input</i>	Input to be entered by the user is displayed in italics.
Links	Links that you can click are displayed in blue font.
"References"	References to other parts of the documentation are enclosed by quotation marks.

2 Introduction

The R&S Signal Generator enables you to generate signals in accordance with the United States Radio Broadcast Data System (RBDS) standard and the European standard CENELEC EN50067 "Specification of the Radio Data System (RDS) for VHF/FM Sound Broadcasting in the frequency Range from 87.5 to 108.0 MHz".

The R&S Signal Generator simulates FM-STEREO signal at the physical layer. The following list gives an overview of the main options provided by the R&S Signal Generator for generating a FM-STEREO signal in accordance with the RDS/RBDS standard:

- Generation of standard compliant FM-Stereo signal with Stereo audio signal and RDS/RBDS signal
- Full configuration of all group types and versions
- Internal modulation sources from LF Generator and wave file for digital stereo signal
- External modulation sources from digital S/P DIF interface for digital stereo signal
- In case of two path instrument, simulation of two independent FM radio transmitters
- Configuration of other networks and alternative frequency list

2.1 Modulation System FM-Stereo

The figure below shows the stereophonic multiplex containing the data signal.

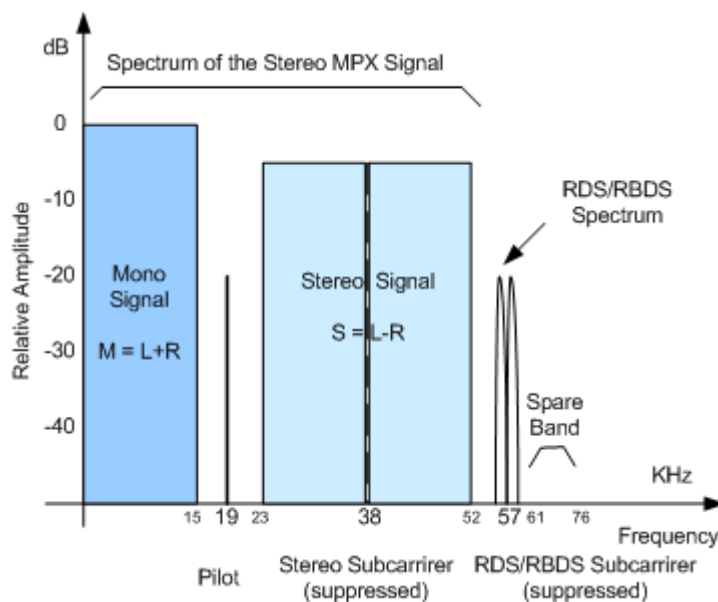

Fig. 2-1: FM baseband spectrum including RDS/RBDS subcarrier

The radio frequency signal consists of a frequency modulated carrier with frequency of 19 kHz and maximum frequency deviation of 80 kHz.

The stereophonic multiplex signal consists of a mono signal, the sidebands of the stereo signal with suppressed subcarrier at 38 kHz and a pilot signal with exactly one half of the subcarrier frequency.

The mono signal M is the sum of the left-hand signal L and the right-hand signal R. The stereo signal S is the difference between the signals L and R. A pre-emphasis can be applied to both L and R signal prior to stereo coding.

The RDS/RBDS subcarrier is locked to the third harmonic of the 19 kHz pilot tone and suppressed.

The R&S Signal Generator enables you to configure the pilot's phase and frequency deviation, the RDS/RBDS subcarrier's phase and frequency deviation and the pre-emphasis. The pilot's phase and the RDS/RBDS subcarrier phase are set with respect to the 38 kHz subcarrier.

The figure below shows the FM-Stereo block diagram.

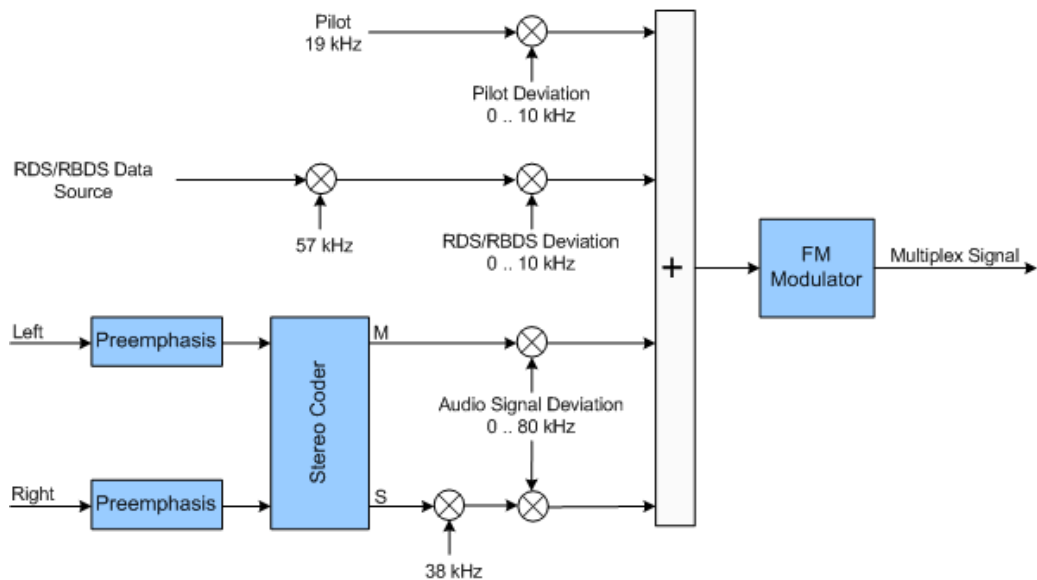

Fig. 2-2: FM-Stereo block diagram

2.2 Baseband Coding and Group Structure

The figure below shows the baseband coding principle.

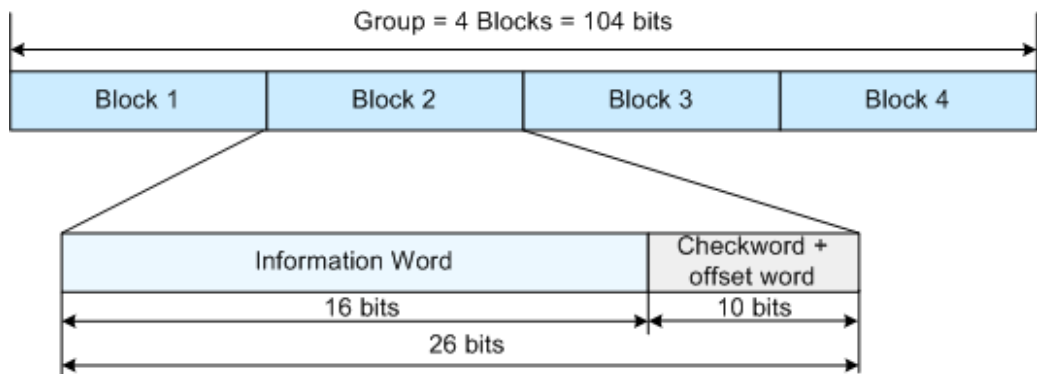

Fig. 2-3: Structure of the baseband coding

The basic element in the signal structure is the group. There are 16 groups (0 to 15) with 104 bits each. Each group consists of 4 blocks, 26 bits each. A block comprises an information word (16 bits) and a check word (10 bits).

Each group has two versions, version A and Version B. The figure below shows the group structure for both versions.

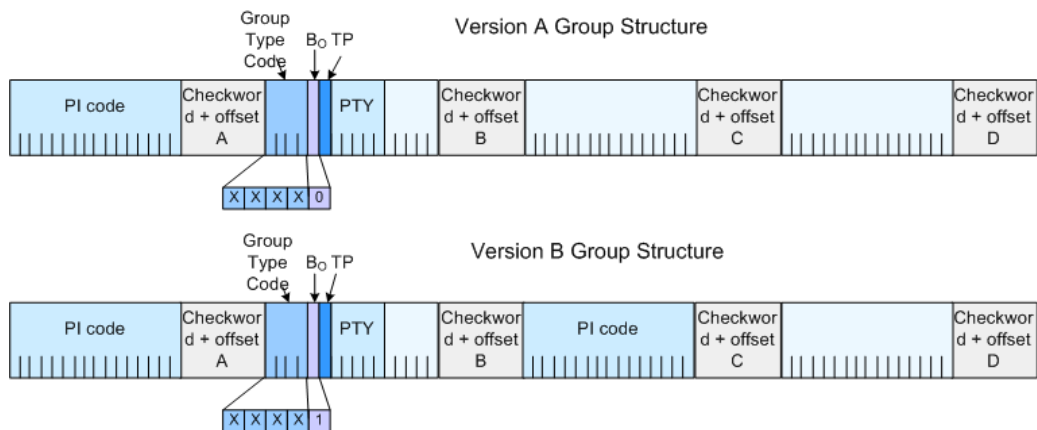

Fig. 2-4: Version A and B group format

The table below gives an overview of the available frame formats per Group Type and Group Type Version. The frame format is displayed in the "RDS/RBDS User Message Table" dialog of the corresponding group type and group type version

Table 2-1: Frame Formats per Group Type and Group Type Version

Group Type	Frame Format for Group Type Version A	Frame Format for Group Type Version B
0		
1		

Group Type	Frame Format for Group Type Version A	Frame Format for Group Type Version B
2		
3		
4		
5		
6		
7		
8		
9		
10		
11		
12		
13		

Group Type	Frame Format for Group Type Version A	Frame Format for Group Type Version B
14		
15		

3 FM-Stereo User Interface

The menu for setting the FM-Stereo digital standard is either called from the baseband block or from the menu tree under "Baseband."



3.1 Main Settings

The menu is split into several sections for configuring the standard.

The upper menu section is where the FM-Stereo digital standard is activated and deactivated and the FM deviation is set. Configuration settings can be stored and already stored configuration settings can be loaded.



In the next two sections, the audio and stereo pilot tone settings are selected.

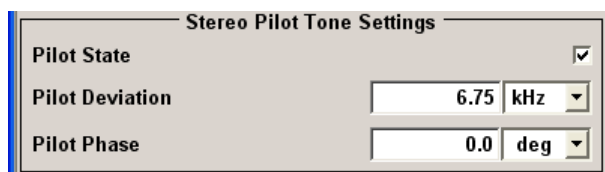
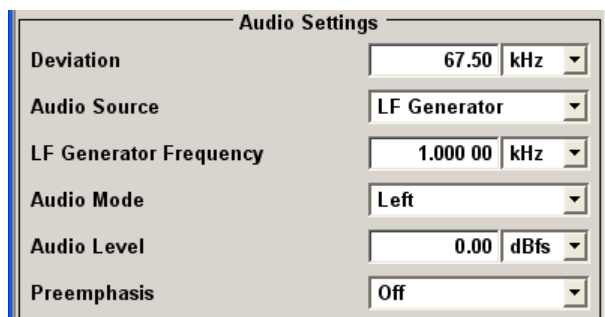

The buttons in the lower menu section lead to submenus for setting the trigger parameters and RDS/RBDS parameters.

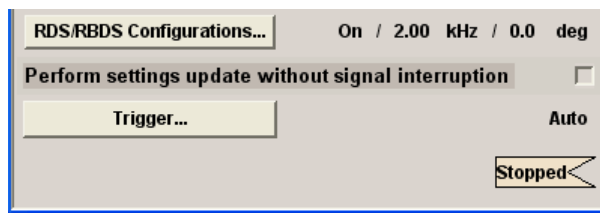

3.1.1 General Settings

State

Activates or deactivates the FM-STEREO standard.

Activating this standard deactivates all the other digital standards and digital modulation modes (in case of two-path instruments, this affects the same path).

The FM-STEREO signal is generated according to the performed settings.

SCPI command:

[\[:SOURce<hw>\]:BB:STEReo:STATe](#) on page 44

Set To Default

Calls the default settings.

Parameter	Value
State	Remains unchanged
Deviation	67 500 Hz
Audio Source	Off
Audio Mode	Mono Left
Audio Level	0 dBfs
Preemphasis	Off
Pilot State	On
Pilot Deviation	6750 Hz
Pilot Phase	0 deg
RDS/RBDS Configuration	On / 2.00 kHz / 0 deg
Trigger	Auto
Perform settings update without signal interruption	On

SCPI command:

[\[:SOURce<hw>\]:BB:STEReo:PRESet](#) on page 44

Save/Recall..

Calls the "Save/Recall" menu.

From the "Save/Recall" menu, the "File Select" windows for saving and recalling FM-STEREO configurations and the "File Manager" is called.



FM-STEREO configurations are stored as files with the predefined file extension `*.fm`. The file name and the directory they are stored in are user-definable.

The complete settings in the "FM-STEREO" menu are saved and recalled.

- "Recall FM-STEREO Setting" Opens the "File Select" window for loading a saved FM-STEREO configuration. The configuration of the selected (highlighted) file is loaded by pressing the "Select" button.
- "Save FM-STEREO Setting" Opens the "File Select" window for saving the current FM-STEREO signal configuration. The name of the file is specified in the "File Name" entry field. The file is saved by pressing the Save button.
- "File Manager" Calls the "File Manager". The "File Manager" is used to copy, delete, and rename files and to create new directories.

SCPI command:

[\[:SOURCE<hw>\]:BB:STEReo:SETTing:CATalog](#) on page 44

[\[:SOURCE<hw>\]:BB:STEReo:SETTing:LOAD](#) on page 45

[\[:SOURCE<hw>\]:BB:STEReo:SETTing:STORe](#) on page 45

3.1.2 Audio Settings

In the "Audio Settings" section, the source for the audio signal and the preemphasis are selected.

Deviation

Sets the frequency deviation of the audio signal, i.e. the deviation of the mono signal M and the stereo signal S (see [figure 2-2](#)).

SCPI command:

[\[:SOURCE<hw>\]:BB:STEReo:DEViation](#) on page 45

Audio Source

Selects the audio source for the FM-Stereo signal.

The sources cannot be used simultaneously.

The following audio sources are available for selection:

- "Off" The audio source is switched off.

"Extern S/P-DIF"

Activates the S/P-DIF input for the external digital modulation signals. For R&S SMBV instruments: The audio source for has to be connected to the MARKER connector on the rear panel. For R&S SMU, R&S SMJ, R&S SMATE and R&S AMU instruments: The audio source for path A/B has to be connected respectively to the USER1/2 connector on the rear panel. The parameters "Map Output Connector User 1 (BNC) / User 2 (AUX I/O) To" in the "User Marker/ AUS I/O" dialog have to be set to General Purpose Input.

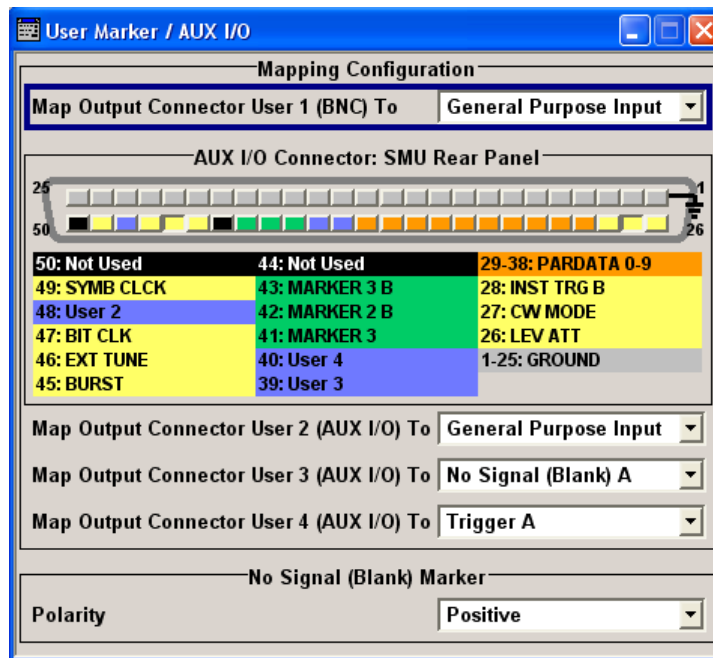

Note that, in case an audio signal is applied to the S/P-DIF interface, an "Extern Clock Source" has to be selected and the parameters "Threshold Trigger/Control Input" and "Impedance Trigger/Control Input" in the

"Global Trigger/Clock/External Inputs" dialog have to be set to 0,01 V and to 1 kOhm respectively.

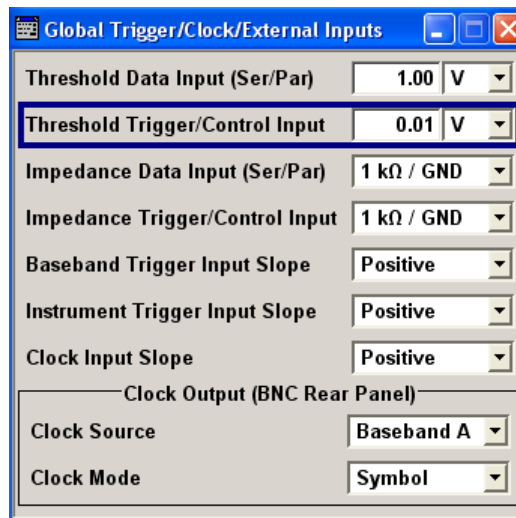

Example:

```
OUTP:USER1:SOUR GPIN
SOUR:INP:TRIG:LEV 0.01
SOUR:INP:TRIG:IMP G1K
```

"LF-Generator" The audio source is generated by the internal LF generator. The frequency of the LF generator is set with the parameter [LF Generator Frequency](#).

"Waveform Audio File" A WAV-File can be selected. Audio files are selected in the [Load Audio File](#) menu.

SCPI command:

```
[ :SOURce<hw> ] :BB:STEReo:SOURce on page 46
```

External Clock

Sets the external clock (44.1 or 48 kHz) in case an extern S/P-DIF audio source is selected.

SCPI command:

```
[ :SOURce<hw> ] :BB:STEReo:AUDio:EXTClock on page 47
```

Load Audio File

Opens the "Load Audio File" menu to select the WAV-File.

SCPI command:

```
[ :SOURce<hw> ] :BB:STEReo:AUDio:DSElect on page 47
```

LF Generator Frequency

Sets the frequency of the LF-Generator in case a LF-Generator is selected as audio source.

SCPI command:

```
[ :SOURce<hw> ] :BB:STEReo:AUDio [ :FREQuency ] on page 48
```

Audio Mode

Sets the way the stereo audio source is mapped in case of mono or stereo operating mode.

"Left"

Audio signal only in the left-hand channel.

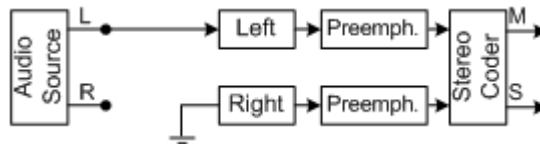

"Right"

Audio signal only in the right-hand channel.

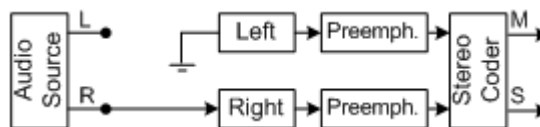

"Stereo
Left=Right"

Audio signal of same frequency and phase in both channels.

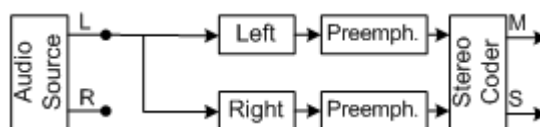

"Stereo Left=-
Right"

Audio signal of same frequency but opposite phase in both channels.

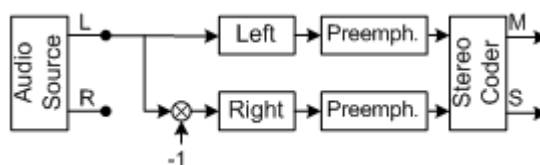

"True Stereo"

Audio signal with true stereo quality, i.e. different and independent signals in both channels.

This audio mode is not possible for audio source LF Generator.

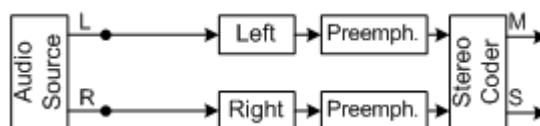

SCPI command:

[\[:SOURCE<hw>\]:BB:STEReo:AUDio:MODE](#) on page 48

Audio Level

Sets the level of the audio signal.

SCPI command:

[\[:SOURCE<hw>\]:BB:STEReo:AUDio:LEVel](#) on page 47

Preemphasis

Enables/disables and sets the preemphasis parameter value to 50 us or 75 us.

SCPI command:

[\[:SOURCE<hw>\]:BB:STEReo:AUDio:PREemphasis](#) on page 48

3.1.3 Stereo Pilot Tone Settings

Pilot State

Enables/disables the 19 kHz pilot tone.

Stereo operating mode is possible with enabled pilot tone only.

SCPI command:

[\[:SOURCE<hw>\]:BB:STEReo:PILot:STATe](#) on page 49

Pilot Deviation

Sets the frequency deviation of the pilot tone (see [figure 2-2](#)).

The parameter is enabled only for enabled pilot tone.

SCPI command:

[\[:SOURCE<hw>\]:BB:STEReo:PILot\[:DEViation\]](#) on page 49

Pilot Phase

Sets the phase of the pilot tone (with respect to the 38 kHz subcarrier).

The parameter is enabled only for enabled pilot tone.

SCPI command:

[\[:SOURCE<hw>\]:BB:STEReo:PILot:PHASe](#) on page 49

3.1.4 RDS/RBDS Parameters

RDS/RBDS Configurations

Calls the "RDS/RBDS Configurations" menu for configuring the RDS/RBDS. The currently selected RDS/RBDS parameters state, deviation and phase are displayed next to the button.

The menu is described in [chapter 3.2, "RDS/RBDS Configuration"](#), on page 19.

SCPI command:

n.a.

Perform settings update without signal interruption

Sets the way the FM signal is calculated in case of parameter update. If this parameter is enabled and some parameters are changed, these parameters are updated but the FM signal will not be interrupted.

Disabling the parameter results in automatically re-calculation of the FM signal after each parameter update. This will disturb the pilot and the receiver has to be re-synchronized.

SCPI command:

[\[:SOURCE<hw>\]:BB:STEReo:PUWSint](#) on page 50

Trigger...

Calls the menu for selecting the trigger mode and trigger source, for configuring the marker signals, and for setting the time delay of an external trigger signal.

This menu is described in [chapter 3.7, "Trigger"](#), on page 41.

The currently selected trigger mode and trigger source are displayed next to the button.

SCPI command:

n.a.

3.2 RDS/RBDS Configuration

The "RDS/RBDS Configuration" menu allows you to configure the RDS/RBDS data.

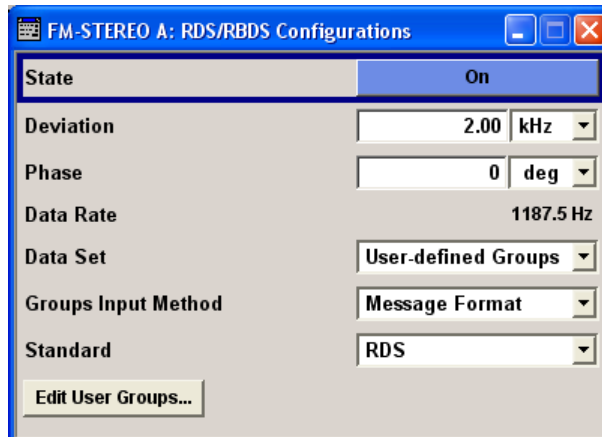

State - RDS/RBDS

Activates/deactivates RDS/RBDS function.

SCPI command:

[\[:SOURce<hw>\]:BB:STEReo:DS:STATe](#) on page 53

Deviation - RDS/RBDS

Sets the frequency deviation of the RDS/RBDS subcarrier (see [figure 2-2](#)).

SCPI command:

[\[:SOURce<hw>\]:BB:STEReo:DS:DEVIation](#) on page 51

Phase - RDS/RBDS

Selects the phase of the RDS/RBDS subcarrier (with respect to the 38 kHz subcarrier).

SCPI command:

[\[:SOURce<hw>\]:BB:STEReo:DS:PHAsE](#) on page 53

Data Rate - RDS/RBDS

Displays the RDS/RBDS data rate in Hz.

SCPI command:

[\[:SOURce<hw>\]:BB:STEReo:DS:DRATe](#) on page 52

Data Set - RDS/RBDS

Selects and activates the RDS/RBDS data set.

- "User-defined Groups" The RDS/RBDS parameters in the "RDS/RBDS Groups Message Settings" or in the "RDS/RBDS Group Hex Table" menu can be configured by the user.
- "Group List" The RDS/RBDS parameters can be loaded from a group list file. "Group List" can be generated internally in the data editor by means of the "Save Groups" button in "RDS/RBDS Groups Message Settings" menu.
The Group lists files have to have an extension `*.fm_gt`.
Group lists are selected in the "Load Group List" window, which is called by means of the "Select Group List" button.

SCPI command:

`[:SOURce<hw>] :BB:STEReo:DS:DSET` on page 52

`[:SOURce<hw>] :BB:STEReo:DS:DSElect` on page 52

Groups Input Method - RDS/RBDS

Selects the input format the RDS/RBDS parameters are represented for editing. There are two input formats: message format or hex table.

The parameter is enabled for data set "User-defined Groups" only.

SCPI command:

`[:SOURce<hw>] :BB:STEReo:DS:GIM` on page 53

Standard - RDS/RBDS

Selects the standard, RDS or RBDS, the signal is generated for.

SCPI command:

`[:SOURce<hw>] :BB:STEReo:DS:MODE` on page 53

Edit User Group - RDS/RBDS

Depending on the selection made for the parameter [Groups Input Method](#), calls the "RDS/RBDS Groups Message Settings" menu or the "RDS/RBDS Group Hex Table" menu for configuring the RDS/RBDS parameters.

The parameter is enabled for data set "User-defined Groups" only.

The menus are described in sections [chapter 3.3.1, "General Settings"](#), on page 21 and [chapter 3.6, "RDS/RBDS Group Hex Table"](#), on page 40.

SCPI command:

n.a.

Select Group List - RDS/RBDS

(enabled for data set Group List only)

Calls the "Load Group List" menu for group file selection.

SCPI command:

`[:SOURce<hw>] :BB:STEReo:DS:DSET` on page 52

`[:SOURce<hw>] :BB:STEReo:DS:DSElect` on page 52

3.3 RDS/RBDS Groups Message Settings

The "RDS/RBDS Settings" menu allows you to configure the RDS/RBDS parameters. The RDS/RBDS parameters are divided into common RDS/RBDS settings and group type specific settings.

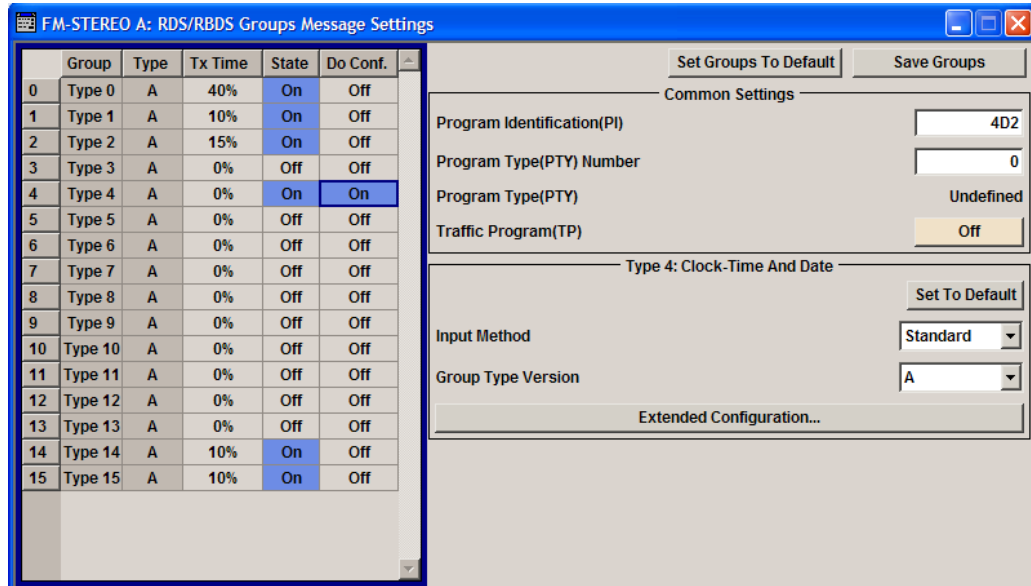

3.3.1 General Settings

Set Groups to Default

Sets all group parameter values to the default settings.

SCPI command:

`[:SOURCE<hw>] :BB:STEReo:GRPS:PRESet` on page 76

Save Groups

Calls "Save Groups" menu for saving the settings to a file with extension `*.fm_gt`.

These files can be then loaded by means of the "Select Group List ..." button in the "RDS/RBDS Configuration" menu.

SCPI command:

`[:SOURCE<hw>] :BB:STEReo:GRPS:STORE` on page 77

3.3.2 Common Settings

Program Identification (PI)

Sets the parameter PI (Program Identification) in hex format.

The PI code is an international network identifier. PI identifies the nation, the coverage area of the service and the radio network. PI can be used for automatically tuning and is transmitted in all the groups.

SCPI command:

[:SOURce<hw>] :BB:STEReo:GRPS:CMNS:PI on page 57

Program Type (PTY) Number

Sets the program type number (see [table 3-1](#)).

The PTY number identifies the content of the program.

PTY can be used for automatically tuning and is transmitted in all the groups.

Table 3-1: RDS/RBDS Program Types

PTY Code	RDS Program Type	RBDS Program Type
0	No program type or undefined	No program type or undefined
1	News	News
2	Current Affairs	Information
3	Information	Sports
4	Sports	Talk
5	Education	Rock
6	Drama	Classic Rock
7	Culture	Adult Hits
8	Science	Soft Rock
9	Varied	Top 40
10	Pop Music	Country
11	Rock Music	Oldies
12	M.O.R. Music	Soft
13	Light classical	Nostalgia
14	Serious classical	Jazz
15	Other Music	Classical
16	Weather	Rhythm and Blues
17	Finance	Soft Rhythm and Blues
18	Children's programs	Foreign Language
19	Social Affairs	Religious Music
20	Religion	Religious Talk
21	Phone In	Personality
22	Travel	Public
23	Leisure	College
24	Jazz Music	Unassigned

PTY Code	RDS Program Type	RBDS Program Type
25	Country Music	Unassigned
26	National Music	Unassigned
27	Oldies Music	Unassigned
28	Folk Music	Unassigned
29	Documentary	Weather
30	Alarm Test	Emergency Test
31	Alarm	Emergency Test

SCPI command:

[:SOURce<hw>] :BB:STEReo:GRPS:CMNS:PTY on page 57

Program Type (PTY)

Displays the program type name of the selected PTY number (see table 3-1).

SCPI command:

n . a .

Traffic Program (TP)

Enables/ disables the traffic program. TP code identifies radio programmes that continuously broadcasts traffic information.

TP can be used for automatically tuning and is transmitted in all the groups.

SCPI command:

[:SOURce<hw>] :BB:STEReo:GRPS:CMNS:TP on page 58

3.3.3 Group Type 0A .. 15B Settings

The parameters in this section depend on the group type selected. To enable a group type for configuration, enable the corresponding parameter **Do Conf.** in the "Group Table". .

The table 3-2 gives an overview of the available RDS/RBDS Group Types.

Table 3-2: RDS/RBDS Group Type Codes

Group Type	Group Type Version	Description
0	A	Basic tuning and switching information only
	B	Basic tuning and switching information only
1	A	Program Item Number and slow labeling codes only
	B	Program Item Number
2	A	Radio text only
	B	Radio text only
3	A	Applications Identification for ODA only

Group Type	Group Type Version	Description
	B	Open Data Applications
4	A	Clock-time and date only
	B	Open Data Applications
5	A	Transparent Data Channels (32 channels) or ODA
	B	Transparent Data Channels (32 channels) or ODA
6	A	In House applications or ODA
	B	In House applications or ODA
7	A	Radio Paging or ODA
	B	Open Data Applications
8	A	Traffic Message Channel or ODA
	B	Open Data Applications
9	A	Emergency Warning System or ODA
	B	Open Data Applications
10	A	Program Type Name
	B	Open Data Applications
11	A	Open Data Applications
	B	Open Data Applications
12	A	Open Data Applications
	B	Open Data Applications
13	A	Enhanced Radio Paging or ODA
	B	Open Data Applications
14	A	Enhanced Other Networks information only
	B	Enhanced Other Networks information only
15	A	Defined in RBDS only
	B	Fast Basic Tuning and Switching Information

Table [table 2-1](#) gives an overview of the available frame formats per Group Type and Group Type Version. The frame format is displayed in the [RDS/RBDS User Message Table](#) dialog of the corresponding group type and group type version

Set to Default

Resets the RDS/RBDS Group specific settings.

Input Method

Selects the format the corresponding group type 0 ..15 will be represented for editing.

"Standard" Configuration based on direct parameter input

"User-defined" Allows configuration of the group type using a user-defined message

SCPI command:

[\[:SOURCE<hw>\]:BB:STEReo:GRPS:GT<st0>:INPMethod](#) on page 62

Group Type Version

Selects A or B as group type version for the corresponding group type.

SCPI command:

[\[:SOURCE<hw>\]:BB:STEReo:GRPS:GT<st0>:VERSion](#) on page 76

Text A/B Flag

(Enabled for "Group Type 2A/B" only)

Sets the Text A/B Flag to 0 (disabled parameter) or 1 (enabled parameter).

Each change of the state of the parameter Text A/B Flag (form 0 to 1 and from 1 to 0) triggers the receiver to clear the radio text and the program type name.

SCPI command:

[\[:SOURCE<hw>\]:BB:STEReo:GRPS:GT<st0>:TABFlag](#) on page 73

Radio Text

(Enabled for "Group Type 2A" and "2B" only)

Sets the radio text.

The radio text is maximum 64 characters long for group type 2A and maximum 32 characters for group type 2B.

If less than 64 respectively 32 characters are used, the unused positions are filled in with zeros (0x00).

SCPI command:

[\[:SOURCE<hw>\]:BB:STEReo:GRPS:GT<st0>:RADText](#) on page 71

A/B Flag

(Enabled for "Group Type 10A/B" only)

Sets the A/B Flag to 0 (disabled parameter) or 1 (enabled parameter).

Each change of the state of the parameter A/B Flag (form 0 to 1 and from 1 to 0) triggers the receiver to clear the radio text and the program type name.

SCPI command:

[\[:SOURCE<hw>\]:BB:STEReo:GRPS:GT<st0>:ABFLag](#) on page 58

Program Type Name

(Enabled for "Group Type 10A" only)

Enters the program type name (max 8 characters).

If less than 8 characters are used, the unused positions are filled in with zeros (0x00).

SCPI command:

[\[:SOURCE<hw>\]:BB:STEReo:GRPS:GT<st0>:PTName](#) on page 69

Extended Configuration .. - RDS/RBDS

(Enabled for "Input Method" set to "Parameters" only)

Calls the "Group 0/4A/14/15B Extended Configuration" menu for configuring the RDS/RBDS parameters.

The menus are described in [chapter 3.4, "Extended Configuration"](#), on page 27.

SCPI command:

n.a.

Edit User Message Table .. - RDS/RBDS

(Enabled for "Input Method" set to "User Message Table" only)

Calls the "RDS/RBDS User Message Table - Group 0A .. 15B" menu for configuring the RDS/RBDS user message parameters in hex format. The checkwords are calculated automatically.

The menus are described in [chapter 3.5, "RDS/RBDS User Message Table - Group 0A .. 15B"](#), on page 39 .

SCPI command:

n.a.

3.3.4 Group Table

The "Group Table" is located in the lower part of the menu.

Group - Group Table

Displays the group type number.

SCPI command:

n.a.

Type - Group Table

Displays the group type version.

SCPI command:

[\[:SOURCE<hw>\]:BB:STEReo:GRPS:GT<st0>:VERSION](#) on page 76

Tx Time - Group Table

Sets the transmit time of the selected group. The transmit time is the group repetition rate given as proportion.

The sum of the transmit times of all groups can not exceed 100%. If the total transmit time is less than 100%, during the rest of the transmit time zeros will be transmitted.

Only groups with "State" set to On are transmitted.

SCPI command:

[\[:SOURCE<hw>\]:BB:STEReo:GRPS:GT<st0>:TTIME](#) on page 74

State - Group Table

Enables/disables the transmission of the corresponding group type.

Only groups with "State" set to On are transmitted.

SCPI command:

[\[:SOURCE<hw>\]:BB:STEReo:GRPS:GT<st0>:STATE](#) on page 71

Do Conf - Group Table

Enables/disables the corresponding group type for configuration. All editable parameters are displayed in the menu section "Group Type 0A .. 15B" (see [chapter 3.5, "RDS/RBDS User Message Table - Group 0A .. 15B"](#), on page 39).

To see the frame format of the selected group type, select "User-defined Input Method" and select "Edit User Message Table".

SCPI command:

n.a.

3.4 Extended Configuration

The menu "Extended Configuration" is enabled only for group types 0A, 0B, 4A, 14A, 14B and 15B.

3.4.1 Group Type 0 - Extended Configuration

The menu is separated into two sections, "Group Type" Parameters and "Alternative Frequency List".

The List of the Alternative Frequencies contains a group of maximum 25 frequencies. The list comprises the frequencies of the station of the same network that broadcast the same radio program within the geographical area concerned.

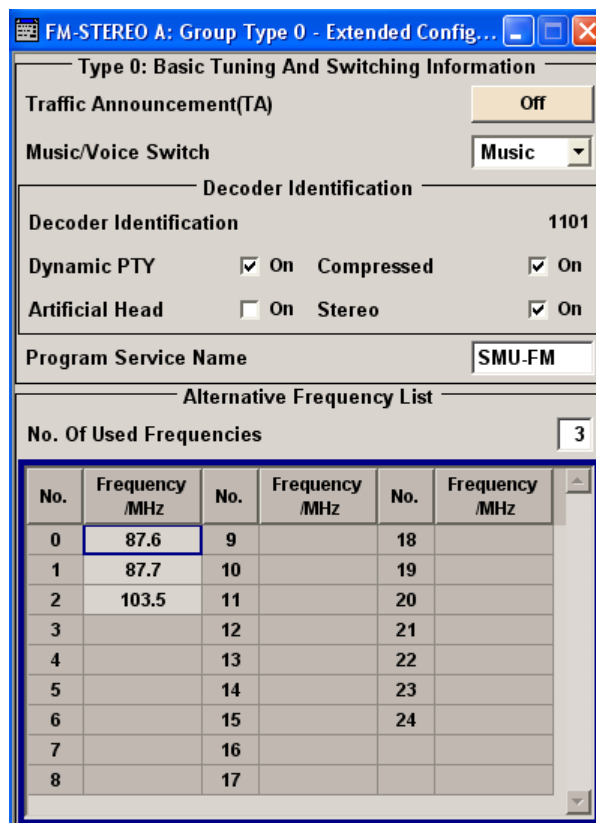

Traffic Announcement

Enables/disables broadcasting of traffic announcement. TA code indicates a traffic communication.

SCPI command:

[:SOURce<hw>] :BB:STEReo:GRPS:GT<st0>:TA on page 72

Music/Voice Switch

Enables switching between speech and music transmission.

SCPI command:

[:SOURce<hw>] :BB:STEReo:GRPS:GT<st0>:MVSWitch on page 67

Decoder Identification (DI)

Displays the decoder identification control code (DI) depending on the settings made for the parameter [Dynamic PTY](#), [Compressed](#), [Artificial Head](#) and [Stereo](#)

The DI is 4-bits long and identifies one of the 16 different operating modes of the decoder. The values of this 4 bits (d_0 , d_1 , d_2 and d_3) are set with the parameters "Stereo", "Artificial Head", "Compressed" and "Dynamic PTY" respectively.

Example:

```
SOUR:BB:STER:GRPS:GT0:DID:DPTY OFF
SOUR:BB:STER:GRPS:GT0:DID:COMP ON
SOUR:BB:STER:GRPS:GT0:DID:ARTH ON
SOUR:BB:STER:RDS:GT0:DID:STER OFF
SOUR:BB:STER:GRPS:GT0:DID:DATA?
Response: 0110
```

SCPI command:

[:SOURce<hw>] :BB:STEReo:GRPS:GT<st0>:DID:DATA on page 61

Dynamic PTY - DI

Enables/disables dynamically PTY switching.

Disabled parameter corresponds to a static PTY and sets the d_3 bit of DI to 0; Dynamic PTY is indicated with 1.

SCPI command:

[:SOURce<hw>] :BB:STEReo:GRPS:GT<st0>:DID:DPTY on page 62

Compressed - DI

Enables/disables the compressed bit of DI.

Disabled parameter sets the d_2 bit of DI to 0; enabled - to 1.

SCPI command:

[:SOURce<hw>] :BB:STEReo:GRPS:GT<st0>:DID:COMPressed on page 61

Artificial Head - DI

Enables/disables using of Artificial Head.

Disabled parameter sets the d_1 bit of DI to 0; enabled - to 1.

SCPI command:

`[:SOURce<hw>] :BB:STEReo:GRPS:GT<st0>:DID:ARTHead` on page 61

Stereo - DI

Sets the mono/stereo switch in the DI.

Disabled parameter corresponds to Mono and sets the d_0 bit of DI to 0; Stereo is indicated with 1.

SCPI command:

`[:SOURce<hw>] :BB:STEReo:GRPS:GT<st0>:DID:STEReo` on page 62

Program Service Name

Enters the program service (PS) name. The PS name is displayed on the receiver and supply the listener with the name of the radio station.

PS cannot be used for automatic search.

The default maximum length of PS is 8 characters.

SCPI command:

`[:SOURce<hw>] :BB:STEReo:GRPS:GT<st0>:PSName` on page 68

No. Of Used Frequencies (Alternative Frequency List)

(Enabled for Group Type Version A only)

Sets the number of alternative frequency to be configured. A maximal number of 25 AFs can be configured.

SCPI command:

`[:SOURce<hw>] :BB:STEReo:GRPS:GT<st0>:ALTF:NOENtries` on page 60

Frequency/ MHz (Alternative Frequency List)

(Enabled for Group Type Version A only)

Sets the alternative frequency (AF) for the broadcast frequency.

The list(s) of alternative frequencies give information on the various transmitters broadcasting the same program in the same or adjacent reception areas, and enable receivers equipped with a memory to store the list(s), to reduce the time for switching to another transmitter.

SCPI command:

`[:SOURce<hw>] :BB:STEReo:GRPS:GT<st0>:ALTF:DATA<ch0>` on page 59

3.4.2 Group Type 4A - Extended Configuration

The Group Type 4 menu displays the clock time and date information.

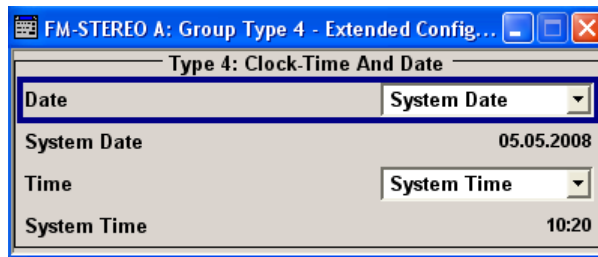
**Date**

Sets the date type to user date or system date.

SCPI command:

[\[:SOURce<hw>\]:BB:STEReo:GRPS:GT<st0>:DATE](#) on page 60

System Date

Displays the system date.

SCPI command:

[\[:SOURce<hw>\]:BB:STEReo:GRPS:GT<st0>:SYSDate](#) on page 72

User Date

Sets the user date in format DD.MM.YYYY.

SCPI command:

[\[:SOURce<hw>\]:BB:STEReo:GRPS:GT<st0>:USRDate](#) on page 75

Time

Sets the time type to system time or user time.

SCPI command:

[\[:SOURce<hw>\]:BB:STEReo:GRPS:GT<st0>:TIME](#) on page 73

System Time

Displays the system time.

SCPI command:

[\[:SOURce<hw>\]:BB:STEReo:GRPS:GT<st0>:SYSTime](#) on page 72

User Time

Sets the user time in format HH:MM.

SCPI command:

[\[:SOURce<hw>\]:BB:STEReo:GRPS:GT<st0>:USRTime](#) on page 76

Local Offset Time

(available for "User Time" only)

Sets the local offset time expressed in multiples of half hours within the range -12h to +12h.

The time is the sum of the user time and the local time offset.

SCPI command:

[\[:SOURce<hw>\]:BB:STEReo:GRPS:GT<st0>:LOTime](#) on page 64

3.4.3 Group Type 14 - Extended Configuration

The menu is separated into two sections, one section that is always displayed, "Group Type" Parameters, and a dynamic one, where the parameters displayed depend on the selection made for the parameter [Information Block](#).

The Group Type 14 has two versions: A and B. The A version is the normal form and shall be used for the background transmission of Enhanced Other Networks information. The B version of a type 14 group is used to indicate a change in the status of the TA flag of a cross-referenced program service.

The Group Type 14 Version A has 16 variants which can be used in any time mixture and order. Variant 4 (AF method A) and variants 5 to 9 (Mapped Frequency Method) are defined for the transmission of frequencies of cross-referenced program services.

The [figure 3-1](#) shows the frame format of group type 14 version A, according to the RDS/RBDS standard.

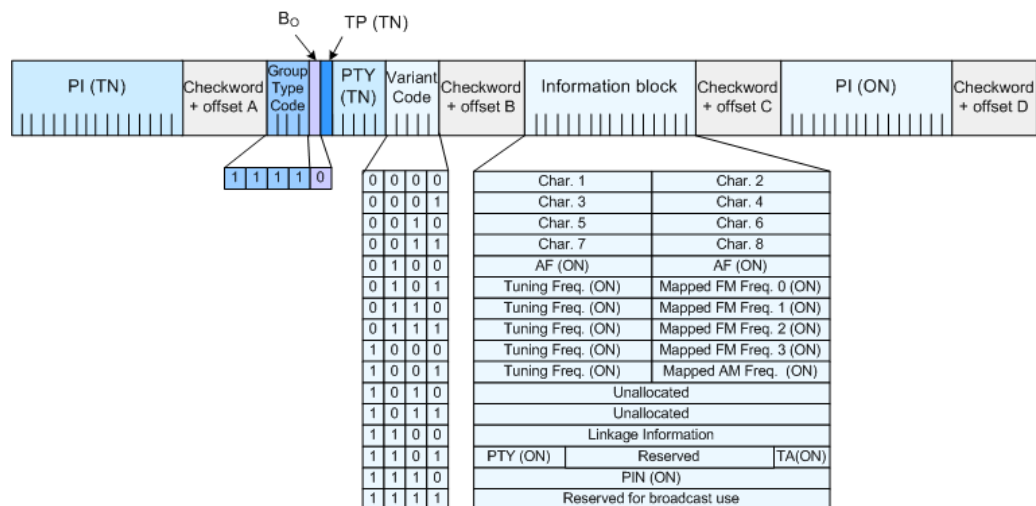

Fig. 3-1: Frame format of group type 14A

Switching between the different PTY variants is performed with the parameter "Information Block".

The [table 3-3](#) gives an overview of the cross-reference between the Group Type 14A variants and the content of the Information Block.

Table 3-3: Information Block Content (Group Type 14A)

Group Type 14A Variant	Information Block
0...3	PS (ON)
4	AF (ON)
5...8	Mapping between Tuning Freq. (TN) and Mapped FM Freq. 0 .. 3 (ON)
9	Mapping between Tuning Freq. (TN) and the Mapped AM Freq. (ON)
10...11	Unallocated
12	Linkage Information

Group Type 14A Variant	Information Block
13	PTY (ON), 10 Reserved Bits, TA (ON)
14	PIN (ON)
15	Reserved for Broadcast use

3.4.3.1 Alternative Frequencies

Alternative Frequencies are set in the Alternative Frequency List. Method AF method A is configured with the parameters "Frequency (ON)". The List of the Alternative Frequencies contains a group of maximum 25 frequencies. The list comprises the frequencies of the stations of the other networks that broadcast the same radio program.

3.4.3.2 Mapped Frequencies

Mapped Frequencies are set in the Mapped Frequency List. The "Mapped Frequency List" sets the cross-reference between the frequency in the tuned network ([Tuning Frequency \(TN\) /MHz](#)) and the corresponding one or more frequencies in other network. The table allows a mapping to more than one VHF/FM frequency ([Mapped Frequency \(ON\) 0 .. 3](#)) and to one LF/MF frequency ([Mapped Frequency \(ON\) 4](#)).

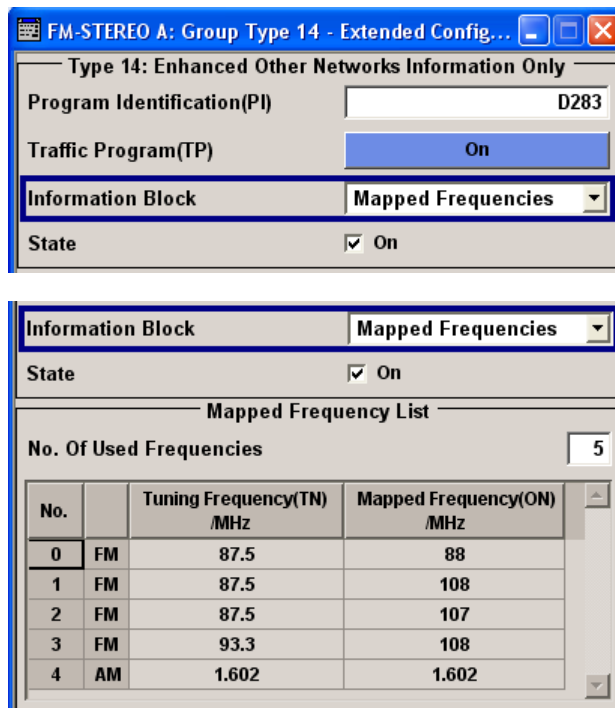

Program Identification (PI) - Other Networks (ON)

Sets the parameter Program Identification of other networks in hex format.

The PI code is an international network identifier. PI identifies the nation, the coverage area of the service and the radio network. PI can be used for automatically tuning and is transmitted in all the groups.

SCPI command:

[:SOURCE<hw>] :BB:STEReo:GRPS:GT<st0>:PION on page 68

Traffic Program (TP) - Other Networks (ON)

Enables/ disables the traffic program of other networks. TP code identifies radio programmes that continuously broadcasts traffic information.

SCPI command:

[:SOURCE<hw>] :BB:STEReo:GRPS:GT<st0>:TPON on page 73

Information Block

(Enabled for group type version A only)

Sets the Group Type 14A variant codes. Depending on the selection made for this parameter; different additional parameters are displayed for configuration.

"Program Service" Sets the content of Information Block Variant Codes 0..3 - PS (ON). vice"

"AF"

Sets the content of Information Block Variant Code 4 - Alternative Frequencies Method A.

No.	Frequency /MHz	No.	Frequency /MHz	No.	Frequency /MHz
0	87.6	9		18	
1	87.7	10		19	
2	107.5	11		20	
3	99.4	12		21	
4		13		22	

"Mapped Frequency" Sets the content of Information Block Variant Codes 5..9 - Mapped Frequencies.

Information Block: Mapped Frequencies

State: On

Mapped Frequency List

No. Of Used Frequencies: 5

No.		Tuning Frequency(TN) /MHz	Mapped Frequency(ON) /MHz
0	FM	87.5	88
1	FM	87.5	108
2	FM	87.5	107
3	FM	93.3	108
4	AM	1.602	1.602

"Linkage Information" Sets the content of Information Block Variant Code 12 - Linkage Information.

Information Block: Linking Information

State: On

Linkage Actuator(LA):

Extended Generic Indicator(EG):

International Linkage Set Ind.:

Linkage Set Number(LSN): 101

"PTY/TA" Sets the content of Information Block Variant Code 13 - PTY (ON) and TA (ON).

Information Block: PTY/TA

State: On

Program Type(PTY) Number: 3

Program Type(PTY): Information

Traffic Announcement(TA):

"PIN" Sets the content of Information Block Variant Code 14 - PIN (ON).

Information Block: PIN

State: On

Program Item Number: 1F3B

SCPI command:
n . a .

State (Program Service) - Other Networks (ON)
(Enabled for group type version A and Information Block set to Program Service only)

Enables/disables sending of program service name of other networks PS (ON).

SCPI command:

[:SOURCE<hw>] :BB:STEReo:GRPS:GT<st0>:PSON:STATe on page 69

Program Service (PS) Name - Other Networks (ON)

(Enabled for group type version A and Information Block set to Program Service only)

Enters the program service name of other networks.

The PS name has a length of max 8 characters. If less than 8 characters are used, the unused positions are filled in with zeros (0x00).

SCPI command:

[:SOURCE<hw>] :BB:STEReo:GRPS:GT<st0>:PSON:PSName on page 69

State (Alternative Frequency)

(Enabled for group type version A and Information Block set to AF only)

Enables/disables using AF method A.

SCPI command:

[:SOURCE<hw>] :BB:STEReo:GRPS:GT<st0>:AFON:STATe on page 59

No. Of Used Frequencies (Alternative Frequency List ON)

(Enabled for Group Type Version A only)

Sets the number of alternative frequency of other networks to be configured. A maximal number of 25 AFs can be configured.

SCPI command:

[:SOURCE<hw>] :BB:STEReo:GRPS:GT<st0>:AFON:NOENtries on page 59

Frequency/ MHz (Alternative Frequency List ON)

(Enabled for Group Type Version A only)

Sets the alternative frequency (AF) of other networks for the broadcast frequency.

The list(s) of alternative frequencies give information on the various transmitters of other networks broadcasting the same program in the same or adjacent reception areas, and enable receivers equipped with a memory to store the list(s), to reduce the time for switching to another transmitter.

SCPI command:

[:SOURCE<hw>] :BB:STEReo:GRPS:GT<st0>:AFON:DATA<ch0> on page 58

State (Mapped Frequencies)

(Enabled for group type version A and Information Block set to Mapped Frequencies only)

Enables/disables using of mapped frequencies.

SCPI command:

[:SOURCE<hw>] :BB:STEReo:GRPS:GT<st0>:MFL:STATe on page 66

No. Of Used Frequencies (Mapped Frequency List)

(Enabled for group type version A and Information Block set to Mapped Frequencies only)

Sets the number of mapped frequency to be configured. A maximal number of 5 frequencies can be configured.

The mapped frequencies are the frequencies of other network that are cross-referenced to the frequencies in the tuned network to allow a transmission of several different services from the same transmitter with the same coverage area.

SCPI command:

`[:SOURCE<hw>] :BB:STEReo:GRPS:GT<st0>:MFL:NOENTries` on page 66

Radio Band (Mapped Frequency List)

(Enabled for group type version A and Information Block set to Mapped Frequencies only)

Displays the radio band, AM or FM, used.

The first four frequencies (Frequency 0 .. 3) are VHF/FM frequencies (FM); the last one (Frequency 4) is a LF/MF frequency (AM).

SCPI command:

n . a .

Tuning Frequency (TN)/ MHz

(Enabled for group type version A and Information Block set to Mapped Frequencies only)

Sets the tuning frequency.

SCPI command:

`[:SOURCE<hw>] :BB:STEReo:GRPS:GT<st0>:MFL:DATA<ch0>:TF` on page 65

Mapped Frequency (ON)/ MHz

(Enabled for group type version A and Information Block set to Mapped Frequencies only)

Sets the FM/AM frequency.

Selected FM/AM frequency is mapped to the tuned frequency.

SCPI command:

`[:SOURCE<hw>] :BB:STEReo:GRPS:GT<st0>:MFL:DATA<ch0>:MF` on page 65

State (Linkage Information)

(Enabled for group type version A and Information Block set to Linkage Information)

Enables/disables using of Linkage Information (ON).

Linkage Information enables the receiver to treat several program services as a single service.

SCPI command:

`[:SOURCE<hw>] :BB:STEReo:GRPS:GT<st0>:LION:STATE` on page 64

Linkage Actuator (LA)

(Enabled for group type version A and Information Block set to Linkage Information)

Enables/disables the Linkage Actuator LA for other networks.

Enabled LA corresponds to active link (LA=1), i.e. the program service is linked to the set of services, set with the [Linkage Set Number \(LSN\)](#).

Disabled LA corresponds to passive link (LA=0), i.e. the link is currently not active but becomes active in the future.

SCPI command:

`[:SOURCE<hw>] :BB:STEReo:GRPS:GT<st0>:LION:LA` on page 63

Extended Generic Indicator (EG)

(Enabled for group type version A and Information Block set to Linkage Information)

Enables/disables the Extended Generic Indicator EG for other networks.

Enabled EG corresponds to EG=1, i.e. the program service is a member of an extended generic set.

SCPI command:

`[:SOURCE<hw>] :BB:STEReo:GRPS:GT<st0>:LION:EG` on page 62

International Linkage Set Ind.

(Enabled for group type version A and Information Block set to Linkage Information)

Enables/disables the International Linkage Set indicator ILS for other networks.

Enabled ILS corresponds to international link (ILS=1).

SCPI command:

`[:SOURCE<hw>] :BB:STEReo:GRPS:GT<st0>:LION:ILS` on page 63

Linkage Set Number (LSN)

(Enabled for group type version A and Information Block set to Linkage Information)

Sets the Linkage Set Number LSN for other networks.

The LSN is a 12 bit number.

SCPI command:

`[:SOURCE<hw>] :BB:STEReo:GRPS:GT<st0>:LION:LSN` on page 63

State (PTY/TA) - Other Networks (ON)

(Enabled for group type version A and Information Block set to PTY/TA)

Enables/disables using of PTY (ON) and TA (ON).

SCPI command:

`[:SOURCE<hw>] :BB:STEReo:GRPS:GT<st0>:PTYTa:STATE` on page 70

Program Type (PTY) Number - Other Networks (ON)

(Enabled for group type version A and Information Block set to PTY/TA)

Sets the program type number of other networks (see [table 3-1](#)).

SCPI command:

`[:SOURCE<hw>] :BB:STEReo:GRPS:GT<st0>:PTYTa:PTY` on page 70

Traffic Announcement (TA) - Other Networks (ON)

Enables/disables the traffic announcement (TA) of other networks. TA code indicates a traffic communication.

SCPI command:

`[:SOURCE<hw>] :BB:STEReo:GRPS:GT<st0>:TAON` on page 73

State (PIN) - Other Networks (ON)

(Enabled for group type version A and Information Block set to PIN)

Enables/disables using of PIN (ON).

SCPI command:

[\[:SOURCE<hw>\]:BB:STEReo:GRPS:GT<st0>:PINon:STATe](#) on page 67

Program Item Number (PIN) - Other Networks (ON)

(Enabled for group type version A and Information Block set to PIN)

Enters the program item number (PIN) of other networks.

The transmitted Program Item Number code is the scheduled broadcast start time and day of month as published by the broadcaster.

SCPI command:

[\[:SOURCE<hw>\]:BB:STEReo:GRPS:GT<st0>:PINon:PIN](#) on page 67

3.4.4 Group Type 15 - Extended Configuration

The Group Type 15 menu displays the basic tuning and switching information, as selected for group type 0.

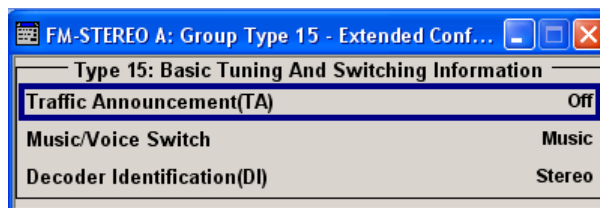

Traffic Announcement

Enables/disables broadcasting of traffic announcement. TA code indicates a traffic communication.

SCPI command:

[\[:SOURCE<hw>\]:BB:STEReo:GRPS:GT<st0>:TA](#) on page 72

Music/Voice Switch

Enables switching between speech and music transmission.

SCPI command:

[\[:SOURCE<hw>\]:BB:STEReo:GRPS:GT<st0>:MVSWithc](#) on page 67

Decoder Identification (DI)

(enabled for group type version B only)

Displays the current decoder operating mode (mono, stereo, rtc.) as selected for group type 0.

SCPI command:

[\[:SOURCE<hw>\]:BB:STEReo:GRPS:GT<st0>:DID:DATA](#) on page 61

3.5 RDS/RBDS User Message Table - Group 0A .. 15B

The "RDS/RBDS User Message" table allows direct configuration of the user message in hex format (see also [chapter 2.2, "Baseband Coding and Group Structure"](#), on page 8).

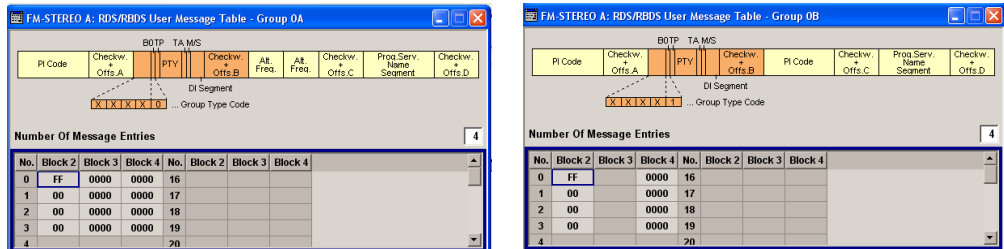

Depending on the selected "Group Type" and "Group Type Version", the frame format is displayed.

No. Of Message Entries (User Message Table)

Sets the number of transmitted groups per message. A maximal number of 32 groups can be configured.

SCPI command:

```
[ :SOURce<hw> ] :BB:STEReo:GRPS:GT<st0>:UMT:NOENTries on page 75
```

Block 2 (User Message Table)

Sets the hex value for Block 2 of the corresponding user message hex table row.

Checkword and offset B are automatically calculated.

SCPI command:

```
[ :SOURce<hw> ] :BB:STEReo:GRPS:GT<st0>:UMT:DATA<ch0>:BLOCK<user> on page 74
```

Block 3 (User Message Table)

(enabled for group type version A only)

Sets the hex value for Block 3 of the corresponding user message hex table row.

Checkword and offset C are automatically calculated.

SCPI command:

```
[ :SOURce<hw> ] :BB:STEReo:GRPS:GT<st0>:UMT:DATA<ch0>:BLOCK<user> on page 74
```

Block 4 (User Message Table)

(enabled for group type version A only)

Sets the hex value for Block 4 of the corresponding user message hex table row.

Checkword and offset D are automatically calculated.

SCPI command:

```
[ :SOURce<hw> ] :BB:STEReo:GRPS:GT<st0>:UMT:DATA<ch0>:BLOCK<user> on page 74
```

3.6 RDS/RBDS Group Hex Table

Alternatively to selecting RDS/RBDS Parameters, the RDS/RBDS Message Blocks can be directly configured in hex format.

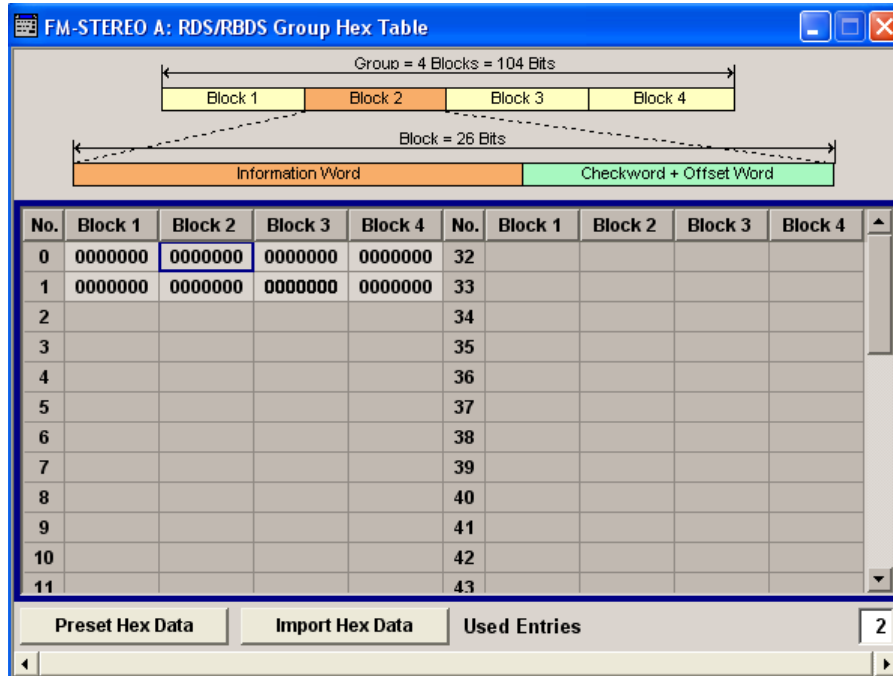

No.
Displays the group hex table row number.

Block 1 .. 4 (Group Hex Table)
Sets the hex value for the Block 1 .. 4 of the corresponding group hex table row.

SCPI command:
`[:SOURce<hw>] :BB:STEReo:GHEX:DATA<ch0>:BLOCk<st>` on page 54

Preset Hex Table
Presets the group hex table.

SCPI command:
`[:SOURce<hw>] :BB:STEReo:GHEX:PRESet` on page 55

Load Hex Data
Opens the "Load Group Hex Data" dialog for loading of group lists files in hex format. The hex file is generated externally and has to have an extension *.fm_ghex.

A group list file in hex format are file with extension *.fm_ghex and the following format:

Parameter	Description
GroupTypeXXX	Group Type and Group Type Version, where XXX=00A, 00B, .. 15A, 15B
:	Separator between the Group Type and the Data Blocks

Parameter	Description
0xNNNNNNNN	where: 0x indicates the data format (hex format) and NNNNNNNN is the 26-bit long data per Block, i.e. the Information Word and the Checkword + Offset Word.
,	Separator between the Data Blocks
//	Comment separator

The figure below gives an example of group list file in hex format.

```
// Type      Block 1   Block 2   Block 3   Block 4
// -----
GroupType00A: 0x0123456, 0x1234567, 0x2345678, 0x3456789 // Comment
GroupType00B: 0x0123456, 0x1234567, 0x2345678, 0x3456789 // Comment
GroupType00A: 0x0123456, 0x1234567, 0x2345678, 0x3456789 // Comment
GroupType00A: 0x0123456, 0x1234567, 0x2345678, 0x3456789 // Comment
GroupType00A: 0x0123456, 0x1234567, 0x2345678, 0x3456789 // Comment
GroupType10A: 0x0123456, 0x1234567, 0x2345678, 0x3456789 // Comment
GroupType11A: 0x0123456, 0x1234567, 0x2345678, 0x3456789 // Comment
GroupType12A: 0x0123456, 0x1234567, 0x2345678, 0x3456789 // Comment
GroupType13A: 0x0123456, 0x1234567, 0x2345678, 0x3456789 // Comment
```

SCPI command:

```
[ :SOURce<hw> ] :BB:STEReo:GHEX:LOAD on page 55
```

Used Entries

Sets the number of messages to be configured. A maximal number of 64 messages can be configured.

SCPI command:

```
[ :SOURce<hw> ] :BB:STEReo:GHEX:NOENtries on page 55
```

3.7 Trigger

To access this dialog, select "Main Menu > Trigger/Marker".

The "Trigger In" section is where the trigger for the signal is set. The current status of signal generation ("Running" or "Stopped") is indicated.

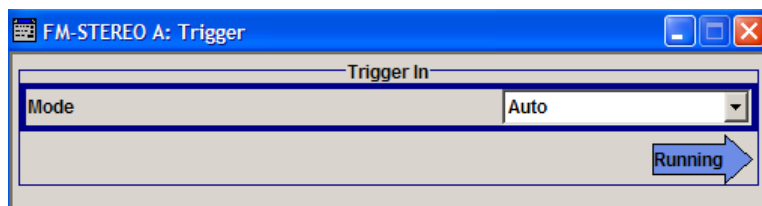

The buttons in the last section lead to submenu for general trigger, clock and mapping settings.



3.7.1 Trigger In

The "Trigger In" section is where the trigger for the signal is set.

The current status of signal generation ("Running" or "Stopped") is indicated for all trigger modes.

Trigger Mode

Selects trigger mode.

The trigger mode determines the effect of a trigger on the signal generation.

"Auto" The signal is generated continuously.

SCPI command:

[\[:SOURce<hw>\]:BB:STEReo\[:TRIGger\]:SEQUence](#) on page 50

Running/Stopped

Displays the status of signal generation for all trigger modes. This display appears only when signal generation is enabled ("State" On).

"Running" The modulation signal is generated; a trigger was (internally or externally) initiated in triggered mode.

"Stopped" The signal is not generated, and the instrument waits for a trigger event (internal or external).

SCPI command:

[\[:SOURce<hw>\]:BB:STEReo:TRIGger:RMODE](#) on page 50

3.7.2 Global Settings

The buttons in this section lead to submenu for general trigger, clock and mapping settings.

Global Trigger/Clock Settings

Calls the "Global Trigger/Clock/Input Settings" dialog.

This dialog is used among other things for setting the trigger threshold, the input impedance and the polarity of the clock and trigger inputs.

In the case of two-path instruments, these settings are valid for both paths.

The parameters in this menu affect all digital modulations and standards, and are described in chapter "Global Trigger/Clock/Input Settings" in the Operating Manual.

User Marker / AUX I/O Settings

Calls the "User Marker AUX I/O Settings" menu, used used to map the connector on the rear of the instruments.

See also "User Marker / AUX I/O Settings" in the Operating Manual.

4 Remote-Control Commands

The commands in the `SOURce:BB:STEReo` subsystem are described in the following section. This subsystem contains commands for the FM-Stereo standard.

These settings concern activation and deactivation of the standard and setting the transmission parameters and trigger settings.

`SOURce<hw>`

For one-path instruments, the keyword `SOURce` is optional and can be omitted.

The numeric suffix to `SOURce` distinguishes between signal generation for path A and path B in the case of two-path instruments:

- `SOURce[1]` = path A
The keyword `SOURce` is optional and can be omitted
- `SOURce2` = path B
The keyword `SOURce` is mandatory, i.e. the command must contain the keyword with suffix 2.

Placeholder `<root>`

For commands that read out or save files in the default directory, the default directory is set using command `MMEM:CDIRectory`. The examples in this description use the placeholder `<root>` in the syntax of the command.

- `D:\` - for selecting the internal hard disk of Windows instruments
- `E:\` - for selecting the memory stick which is inserted at the USB interface of Windows instruments
- `/var/<instrument>` - for selecting the internal flash card of Linux instrument, where `<instrument>` is the instrument name, e.g. `smbv`.
- `/usb` - for selecting the memory stick which is inserted at the USB interface of Linux instrument.

4.1 Primary Commands

<code>[:SOURce<hw>]:BB:STEReo:STATe</code>	44
<code>[:SOURce<hw>]:BB:STEReo:PRESet</code>	44
<code>[:SOURce<hw>]:BB:STEReo:SETTing:CATalog</code>	44
<code>[:SOURce<hw>]:BB:STEReo:SETTing:LOAD</code>	45
<code>[:SOURce<hw>]:BB:STEReo:SETTing:STORE</code>	45
<code>[:SOURce<hw>]:BB:STEReo:DEVIation</code>	45
<code>[:SOURce<hw>]:BB:STEReo:SOURce</code>	46
<code>[:SOURce<hw>]:BB:STEReo:AUDio:CATalog</code>	46
<code>[:SOURce<hw>]:BB:STEReo:AUDio:DSElect</code>	47
<code>[:SOURce<hw>]:BB:STEReo:AUDio:EXTClock</code>	47
<code>[:SOURce<hw>]:BB:STEReo:AUDio:LEVel</code>	47
<code>[:SOURce<hw>]:BB:STEReo:AUDio:MODE</code>	48
<code>[:SOURce<hw>]:BB:STEReo:AUDio:PREEmphasis</code>	48

<code>[:SOURce<hw>]:BB:STEReo:AUDio[:FREQuency]</code>	48
<code>[:SOURce<hw>]:BB:STEReo:PILot:PHASe</code>	49
<code>[:SOURce<hw>]:BB:STEReo:PILot:STATe</code>	49
<code>[:SOURce<hw>]:BB:STEReo:PILot[:DEViation]</code>	49
<code>[:SOURce<hw>]:BB:STEReo:PUWSint</code>	50
<code>[:SOURce<hw>]:BB:STEReo:TRIGger:RMODE</code>	50
<code>[:SOURce<hw>]:BB:STEReo[:TRIGger]:SEQuence</code>	50

`[:SOURce<hw>]:BB:STEReo:STATe <State>`

Activates or deactivates the FM Stereo standard.

Activating this standard deactivates all the other digital standards and digital modulation modes.

In case of two-path instruments, this affects the same path.

The FM Stereo signal is generated according to the performed settings.

Parameters:

`<State>` 0|1|OFF|ON

`*RST:` 0

Example:

`SOUR:BB:STER:STAT ON`

activates modulation in accordance with the FM-STEREO standard.

`[:SOURce<hw>]:BB:STEReo:PRESet`

The command produces a standardized default for the FM Stereo standard. The settings correspond to the `*RST` values specified for the commands.

Example:

`BB:STER:PRESet`

resets all the FM-stereo settings to default values.

`[:SOURce<hw>]:BB:STEReo:SETTing:CATalog <Catalog>`

Reads out the files with FM-STEREO settings in the default directory.

The directory is set using command `MMEM:CDIRectory`. A path can also be specified, in which case the files in the specified directory are read. The file extension may be omitted. Only files with the file extension `*.fm` will be listed.

Parameters:

`<Catalog>` string

Example: `MMEM:CDIR '<root>/user/FMSTereo'`
 sets the default directory to <root>/user/FMSTereo
`SOUR:BB:STER:SETT:CAT?`
 reads out all the files with FM Stereo settings in the default directory
 Response: `fm_stereo1, fm_stereo 2`

[:SOURce<hw>]:BB:STEReo:SETTing:LOAD <Load>

Loads the selected file with FM Stereo settings.

The directory is set using command `MMEM:CDIRectory`. A path can also be specified, in which case the files in the specified directory are read. The file extension may be omitted. Only files with the file extension `*.fm` will be loaded.

Parameters:

<Load> string

Example: `SOUR:BB:STER:SETT:LOAD 'fm_configuration1'`
 loads the file `fm_configuration1.fm`

[:SOURce<hw>]:BB:STEReo:SETTing:STORe <Store>

Stores the selected file with FM-STEREO settings.

The directory is set using command `MMEM:CDIRectory`. A path can also be specified, in which case the files in the specified directory are read. The file extension may be omitted. FM-STEREO settings are stored as files with the specific file extension `*.fm`.

Parameters:

<Store> string

Example: `SOUR:BB:STER:SETT:STOR 'fm_configuration1'`
 stores the current setting

[:SOURce<hw>]:BB:STEReo:DEViation <Deviation>

Sets the frequency deviation of the stereo signal.

Parameters:

<Deviation> float

Range: 0 to 75000

*RST: 67500

Example: `SOURce:BB:STER:DEV 70000`
 sets the deviation value 70kHz

[:SOURce<hw>]:BB:STEReo:SOURce <Source>

Selects the audio source for the FM-Stereo signal.

The sources cannot be used simultaneously.

Parameters:

<Source>

OFF|SPEXt|LFGen|FILE

OFF

The audio source is switched off.

SPEXt

Activates the S/P-DIF input for the external digital modulation signals.

for R&S SMU/SMJ/SMATE and R&S AMU instruments:

The audio source for path A/B has to be connected respectively to the USER1/2 connector on the rear panel.

for R&S SMBV instrument:

The audio source has to be connected to the MARKER connector on the rear panel.

Note: In case an audio signal is applied to the S/P-DIF interface, an "Extern Clock Source" has to be selected and the parameter "Threshold Trigger/Control Input" has to be set to 0,01 V.

LFGen

The audio source is generated by the internal LF generator.

The frequency of the LF generator is set with the command [:

SOURce<hw>]:BB:STEReo:AUDio[:FREQuency].

FILE

A WAV-File can be selected. Audio files are selected with the command [:SOURce<hw>]:BB:STEReo:AUDio:DSElect

*RST: 0

Example:

SOUR:BB:STER:SOUR LFG

selects the audio source

SOUR:BB:STER:AUD:FREQ 1000

sets the LF Generator Frequency

[:SOURce<hw>]:BB:STEReo:AUDio:CATalog <Catalog>

Reads out the Waveform files in the default directory.

The directory is set using command `MMEM:CDIRectory`. A path can also be specified, in which case the files in the specified directory are read. The file extension may be omitted. Only files with the file extension `*.wav` will be listed.

Parameters:

<Catalog>

string

Example: MMEM:CDIR '<root>/user/FMStereo'
 sets the default directory to <root>/user/FMStereo
 SOUR:BB:STER:AUD:CAT?
 reads out all the waveform files in the default directory
 Response: fm_stereo_waveform1,
 fm_stereo_waveform2

[:SOURCE<hw>]:BB:STEReo:AUDio:DSElect <Dselect>

Loads the selected file with audio data. The file extension may be omitted. Only files with the file extension *.wav will be loaded.

Parameters:

<Dselect> string

Example: SOUR:BB:STER:SOUR FILE
 selects the audio source
 MMEM:CDIR '<root>/user/waveforms'
 sets the default directory to <root>/user/waveforms
 SOUR:BB:STER:AUD:DSEL 'fm_wave'
 loads the audio file fm_wave.wav from the default directory

[:SOURCE<hw>]:BB:STEReo:AUDio:EXTClock <Extclock>

Sets the external clock (44.1 or 48 kHz) in case an extern S/P-DIF audio source is selected.

Parameters:

<Extclock> 44100|48000
 *RST: 44100

Example: SOUR:BB:STER:SOUR SPEX
 selects the audio source
 SOUR:BB:STER:AUD:EXTC 48000
 sets the external clock to 48 kHz

[:SOURCE<hw>]:BB:STEReo:AUDio:LEVel <Level>

Sets the level of the audio signal.

Parameters:

<Level> float
 Range: -30.00 to 10.00
 Increment: 0.01
 *RST: 0 dBfs
 Default unit: dBfs

Example: `SOUR:BB:STER:AUD:LEV -10.00`
sets the audio level –10dBfs

[:SOURCE<hw>]:BB:STEReo:AUDio:MODE <Mode>

Selects the operating mode.

Parameters:

<Mode>

LEFT|RIGHT|RELeft|REMLLeft|RNELeft

LEFT

Audio signal only in the left-hand channel

RIGHT

Audio signal only in the left-hand channel

RELeft

Audio signals of the same frequency and phase in both channels

REMLLeft

Audio signals of same frequency but opposite phase in both channels

RNELeft

Different and independent audio signals in both channels
(not possible with source selection LF Generator)

*RST: RNELeft

Example: `SOUR:BB:STER:AUDio:MODE RNEL`
sets the audio mode to true stereo

[:SOURCE<hw>]:BB:STEReo:AUDio:PREEmphasis <Preemphasis>

Enables/disables and sets the preemphasis parameter value to 50us or 75us.

Parameters:

<Preemphasis>

OFF|US50|US75

*RST: OFF

Example: `SOUR:BB:STER:AUD:PRE US50`
sets the preemphasis to 50 us

[:SOURCE<hw>]:BB:STEReo:AUDio[:FREQUENCY] <Frequency>

Sets the frequency of the LF-Generator in case a LF-Generator is selected as audio source.

Parameters:

<Frequency> float
 Range: 20 Hz to 15000 Hz
 Increment: 0.01
 *RST: 1000 Hz

Example:

SOUR:BB:STER:SOUR LFG
 selects the audio source
 SOUR:BB:STER:AUD:FREQ 1000
 sets the LF Generator Frequency to 1 kHz

[[:SOURce<hw>]:BB:STEReo:PILot:PHASe <Phase>

Sets the phase of the pilot tone (with respect to the 38 kHz subcarrier). The parameter is enabled only for enabled pilot tone.

Parameters:

<Phase> float
 Range: -50 deg to 50 deg
 Increment: 0.1 deg
 *RST: 0

Example:

SOUR:BB:STER:PIL:PHAS -3
 sets the phase to 3 degrees

[[:SOURce<hw>]:BB:STEReo:PILot:STATe <State>

Enables/disables the pilot tone.

Stereo operating mode is possible with enabled pilot tone only.

Parameters:

<State> 0|1|OFF|ON
 *RST: ON

Example:

SOUR:BB:STER:PIL:STAT ON
 enables pilot tone

[[:SOURce<hw>]:BB:STEReo:PILot[:DEViation] <Deviation>

Sets the frequency deviation of the pilot tone. The parameter is enabled only for enabled pilot tone.

Parameters:

<Deviation> float

Range: 0 to 10000 Hz
 Increment: 10 Hz
 *RST: 6750 Hz

Example:

SOUR:BB:PIL:DEV 5000
 sets the deviation of the pilot tone to 5 kHz

[[:SOURce<hw>]:BB:STEReo:PUWSint <Puwsint>

Sets the way the FM signal is calculated in case of parameter update.

If this parameter is enabled and some parameters are changed, these parameters are updated but the FM signal will not be interrupted.

Disabling the parameter results in automatically re-calculation of the FM signal after each parameter update. This will disturb the pilot and the receiver has to be re-synchronized.

Parameters:

<Puwsint> 0|1|OFF|ON

*RST: ON

Example:

SOUR:BB:STER:PUWS ON
 enables FM Stereo signal generation without interruption

[[:SOURce<hw>]:BB:STEReo:TRIGger:RMODE <Rmode>

The command queries the current status of signal generation for all trigger modes with FM Stereo modulation on.

Parameters:

<Rmode> STOP|RUN

RUN
 the signal is generated. A trigger event occurred in the triggered mode.

STOP
 the signal is not generated.

*RST: STOP

Example:

BB:STER:TRIG:RMOD?
 queries the current status of signal generation.
 Response: RUN
 the signal is generated

[[:SOURce<hw>]:BB:STEReo[:TRIGger]:SEQUence <Sequence>

Sets the trigger mode.

Parameters:

<Sequence> AUTO
AUTO
 The modulation signal is generated continuously.
 *RST: AUTO

Example:

BB:STER:SEQ AUTO
 sets the Auto trigger mode

4.2 RDS/RBDS Configurations

[:SOURce<hw>]:BB:STEReo:DS:CATalog.....	51
[:SOURce<hw>]:BB:STEReo:DS:DEVIation.....	51
[:SOURce<hw>]:BB:STEReo:DS:DRATe.....	52
[:SOURce<hw>]:BB:STEReo:DS:DSElect.....	52
[:SOURce<hw>]:BB:STEReo:DS:DSET.....	52
[:SOURce<hw>]:BB:STEReo:DS:GIM.....	53
[:SOURce<hw>]:BB:STEReo:DS:MODE.....	53
[:SOURce<hw>]:BB:STEReo:DS:PHAsE.....	53
[:SOURce<hw>]:BB:STEReo:DS:STATe.....	53

[:SOURce<hw>]:BB:STEReo:DS:CATalog <Catalog>

Reads out the files with the group list settings in the default directory.

The directory is set using command `MMEM:CDIRectory`. A path can also be specified, in which case the files in the specified directory are read. The file extension may be omitted. Only files with the file extension `*.fm_gt` will be listed.

Parameters:

<Catalog> string

Example:

```
MMEM:CDIR '<root>/user/FMStereo'
sets the default directory to <root>/user/FMStereo
SOUR:BB:STER:DS:CAT?
reads out all the files with group lists settings in the default directory
Response: fm_stereo_GL1, fm_stereo_GL2
```

[:SOURce<hw>]:BB:STEReo:DS:DEVIation <Deviation>

Sets the frequency deviation of the RDS/RBDS subcarrier.

Parameters:

<Deviation> float

Range: 0 to 10000

*RST: 2000

Example:

SOUR:BB:STER:DS:DEV 5000

sets the deviation to 5 kHz

[[:SOURce<hw>]:BB:STEReo:DS:DRATe?

Queries the data rate.

Return values:

<Drate> float

Example:

SOUR:BB:STER:DS:DRATe?

queries the data rate

Response: 1187.5

Usage:

Query only

[[:SOURce<hw>]:BB:STEReo:DS:DSElect <Dselect>

Selects the group list.

Parameters:

<Dselect> string

Example:

BB:STER:DS:DSET GRPL

selects group lists

BB:STER:DS:DSEL 'fm_group_list'

selects the group list file

[[:SOURce<hw>]:BB:STEReo:DS:DSET <Dset>

Selects and activates the RDS/RBDS data set.

Parameters:

<Dset> UDGRoups|GRPList

UDGRoups

User-defined Groups

GRPList

the RDS/RBDS parameter are loaded from group lists files

*RST: UDGRoups

Example: `BB:STER:DS:DSET GRPL`
selects group list files

[:SOURCE<hw>]:BB:STEReo:DS:GIM <Gim>

Sets the input method.

Parameters:

<Gim> MSGFormat|HEXFormat

MSGFormat

Message Format

HEXFormat

Hex Format

*RST: MSGFormat

Example: `BB:STEReo:DS:GIM HEXF`
selects the group input method Hex Format

[:SOURCE<hw>]:BB:STEReo:DS:MODE <Mode>

Selects the standard, RDS (Radio Data System) or RBDS (Radio Broadcast Data System), the signal is generated for.

Parameters:

<Mode> RDS|RBDS

*RST: RDS

Example: `SOUR:BB:STER:DS:MODE RBDS`
selects the Radio Broadcast Data System.

[:SOURCE<hw>]:BB:STEReo:DS:PHase <Phase>

Selects the phase of the RDS/RBDS subcarrier (with respect to the 38 kHz subcarrier).

Parameters:

<Phase> float

Range: 0 deg to 359.9 deg

Increment: 0.1

*RST: 0

Example: `SOUR:BB:STER:DS:PHase 10.1`
sets a phase of 10.1 degrees.

[:SOURCE<hw>]:BB:STEReo:DS:STATe <State>

Activates/deactivates RDS/RBDS function.

Parameters:

<State> 0|1|OFF|ON
 *RST: ON

Example:

SOUR:BB:STER:DS:STAT ON
 activates the RDS/RBDS function

4.3 Group Hex Settings

[:SOURce<hw>]:BB:STEReo:GHEX:CATalog.....	54
[:SOURce<hw>]:BB:STEReo:GHEX:DATA<ch0>:BLOCk<st>.....	54
[:SOURce<hw>]:BB:STEReo:GHEX:LOAD.....	55
[:SOURce<hw>]:BB:STEReo:GHEX:NOENTries.....	55
[:SOURce<hw>]:BB:STEReo:GHEX:PRESet.....	55
[:SOURce<hw>]:BB:STEReo:GHEX:STORE.....	56

[:SOURce<hw>]:BB:STEReo:GHEX:CATalog <Catalog>

Reads out the files in hex format with the group list settings in the default directory.

The directory is set using command `MMEM:CDIRectory`. A path can also be specified, in which case the files in the specified directory are read. The file extension may be omitted. Only files with the file extension `*.fm_ghex` will be listed.

Parameters:

<Catalog> string

Example:

```
MMEM:CDIR '

```

[:SOURce<hw>]:BB:STEReo:GHEX:DATA<ch0>:BLOCk<st> <Block>

Sets the block data.

Suffix:

<ch0> 0 .. 63

<st> 0 .. 3

Parameters:

<Block> float
 Range: 0 to #H3FFFFFFF
 Increment: 1
 *RST: 0

Example:

SOUR:BB:STER:GHEX:DATA2:BLOC3 #HA6BE
 sets the hex value #HA6BE for block 3 at group hex row index 2.

[:SOURce<hw>]:BB:STEReo:GHEX:LOAD <Load>

Loads the selected file with group hex settings.

The directory is set using command `MMEM:CDIRECTory`. A path can also be specified, in which case the files in the specified directory are read. The file extension may be omitted. Only files with the file extension `*.fm_ghex` will be loaded.

Parameters:

<Load> string

Example:

SOUR:BB:STER:GHEX:LOAD 'fm_stereo_GL_hex1'
 loads the file `fm_stereo_GL_hex1.fm`

[:SOURce<hw>]:BB:STEReo:GHEX:NOENtries <Noentries>

Sets the number of used group hex entries.

Parameters:

<Noentries> float
 Range: 0 to 64
 *RST: 0

Example:

SOUR:BB:STER:GHEX:NOEN 5
 selects 3 used group hex entries for signal generation

[:SOURce<hw>]:BB:STEReo:GHEX:PRESet

The command resets the group hex table.

Example:

BB:STER:GHEX:PRES
 resets the group hex table.

Usage:

Event

[:SOURce<hw>]:BB:STEReo:GHEX:STORe <Store>

Stores the current RDS/RBDS Group Hex Settings into the selected file. The directory is set using command `MMEM:CDIRectory`. A path can also be specified, in which case the files in the specified directory are read. Only the file name has to be entered.

Parameters:

<Store> <file name>

Example:

`SOUR:BB:STER:GHEX:STOR 'fm_groups'`
saves the RDS/RBDS Group Hex Settings into the file

Usage:

Setting only

4.4 RDS/RBDS Group Settings

<code>[:SOURce<hw>]:BB:STEReo:GRPS:AGPRReset</code>	57
<code>[:SOURce<hw>]:BB:STEReo:GRPS:CMNS:PI</code>	57
<code>[:SOURce<hw>]:BB:STEReo:GRPS:CMNS:PTY</code>	57
<code>[:SOURce<hw>]:BB:STEReo:GRPS:CMNS:TP</code>	58
<code>[:SOURce<hw>]:BB:STEReo:GRPS:GT<st0>:ABFLag</code>	58
<code>[:SOURce<hw>]:BB:STEReo:GRPS:GT<st0>:AFON:DATA<ch0></code>	58
<code>[:SOURce<hw>]:BB:STEReo:GRPS:GT<st0>:AFON:NOENtries</code>	59
<code>[:SOURce<hw>]:BB:STEReo:GRPS:GT<st0>:AFON:STATe</code>	59
<code>[:SOURce<hw>]:BB:STEReo:GRPS:GT<st0>:ALTF:DATA<ch0></code>	59
<code>[:SOURce<hw>]:BB:STEReo:GRPS:GT<st0>:ALTF:NOENtries</code>	60
<code>[:SOURce<hw>]:BB:STEReo:GRPS:GT<st0>:DATE</code>	60
<code>[:SOURce<hw>]:BB:STEReo:GRPS:GT<st0>:DID:ARTHead</code>	61
<code>[:SOURce<hw>]:BB:STEReo:GRPS:GT<st0>:DID:COMPressed</code>	61
<code>[:SOURce<hw>]:BB:STEReo:GRPS:GT<st0>:DID:DATA</code>	61
<code>[:SOURce<hw>]:BB:STEReo:GRPS:GT<st0>:DID:DPTY</code>	62
<code>[:SOURce<hw>]:BB:STEReo:GRPS:GT<st0>:DID:STEReo</code>	62
<code>[:SOURce<hw>]:BB:STEReo:GRPS:GT<st0>:INPMethod</code>	62
<code>[:SOURce<hw>]:BB:STEReo:GRPS:GT<st0>:LION:EG</code>	62
<code>[:SOURce<hw>]:BB:STEReo:GRPS:GT<st0>:LION:ILS</code>	63
<code>[:SOURce<hw>]:BB:STEReo:GRPS:GT<st0>:LION:LA</code>	63
<code>[:SOURce<hw>]:BB:STEReo:GRPS:GT<st0>:LION:LSN</code>	63
<code>[:SOURce<hw>]:BB:STEReo:GRPS:GT<st0>:LION:STATe</code>	64
<code>[:SOURce<hw>]:BB:STEReo:GRPS:GT<st0>:LOTTime</code>	64
<code>[:SOURce<hw>]:BB:STEReo:GRPS:GT<st0>:MFL:DATA<ch0>:MF</code>	65
<code>[:SOURce<hw>]:BB:STEReo:GRPS:GT<st0>:MFL:DATA<ch0>:TF</code>	65
<code>[:SOURce<hw>]:BB:STEReo:GRPS:GT<st0>:MFL:NOENtries</code>	66
<code>[:SOURce<hw>]:BB:STEReo:GRPS:GT<st0>:MFL:STATe</code>	66
<code>[:SOURce<hw>]:BB:STEReo:GRPS:GT<st0>:MVSWitch</code>	67
<code>[:SOURce<hw>]:BB:STEReo:GRPS:GT<st0>:PINon:PIN</code>	67
<code>[:SOURce<hw>]:BB:STEReo:GRPS:GT<st0>:PINon:STATe</code>	67
<code>[:SOURce<hw>]:BB:STEReo:GRPS:GT<st0>:PION</code>	68
<code>[:SOURce<hw>]:BB:STEReo:GRPS:GT<st0>:PSName</code>	68

[:SOURce<hw>]:BB:STEReo:GRPS:GT<st0>:PSON:PSName.....69
 [:SOURce<hw>]:BB:STEReo:GRPS:GT<st0>:PSON:STATE.....69
 [:SOURce<hw>]:BB:STEReo:GRPS:GT<st0>:PTName.....69
 [:SOURce<hw>]:BB:STEReo:GRPS:GT<st0>:PTYTa:PTY.....70
 [:SOURce<hw>]:BB:STEReo:GRPS:GT<st0>:PTYTa:STATE.....70
 [:SOURce<hw>]:BB:STEReo:GRPS:GT<st0>:PTYTa:TA.....70
 [:SOURce<hw>]:BB:STEReo:GRPS:GT<st0>:RADText.....71
 [:SOURce<hw>]:BB:STEReo:GRPS:GT<st0>:STATE.....71
 [:SOURce<hw>]:BB:STEReo:GRPS:GT<st0>:SYSDate.....72
 [:SOURce<hw>]:BB:STEReo:GRPS:GT<st0>:SYSTime.....72
 [:SOURce<hw>]:BB:STEReo:GRPS:GT<st0>:TA.....72
 [:SOURce<hw>]:BB:STEReo:GRPS:GT<st0>:TABFlag.....73
 [:SOURce<hw>]:BB:STEReo:GRPS:GT<st0>:TAON.....73
 [:SOURce<hw>]:BB:STEReo:GRPS:GT<st0>:TIME.....73
 [:SOURce<hw>]:BB:STEReo:GRPS:GT<st0>:TPON.....73
 [:SOURce<hw>]:BB:STEReo:GRPS:GT<st0>:TTIME.....74
 [:SOURce<hw>]:BB:STEReo:GRPS:GT<st0>:UMT:DATA<ch0>:BLOCK<user>.....74
 [:SOURce<hw>]:BB:STEReo:GRPS:GT<st0>:UMT:NOENtries.....75
 [:SOURce<hw>]:BB:STEReo:GRPS:GT<st0>:USRDate.....75
 [:SOURce<hw>]:BB:STEReo:GRPS:GT<st0>:USRTIME.....76
 [:SOURce<hw>]:BB:STEReo:GRPS:GT<st0>:VERSion.....76
 [:SOURce<hw>]:BB:STEReo:GRPS:PRESet.....76
 [:SOURce<hw>]:BB:STEReo:GRPS:STORe.....77

[:SOURce<hw>]:BB:STEReo:GRPS:AGPReset

Sets the parameter values of the active group to the default settings.

Example: BB : STER : GRPS : AGPR
 sets the active group ro default

Usage: Event

[:SOURce<hw>]:BB:STEReo:GRPS:CMNS:PI <Pi>

Sets the parameter PI (Program Identification). The input format is hex format or decimal format with 4 symbols length.

Parameters:
 <Pi> float
 Range: 0 to #HFFFF
 *RST: #HD238

Example: SOUR : BB : STER : GRPS : CMNS : PI #HAB18
 sets the PI to #HAB18

[:SOURce<hw>]:BB:STEReo:GRPS:CMNS:PTY <Pty>

Sets the program type number. The PTY number identifies the content of the program.

Parameters:

<Pty> float
 Range: 1 to 31
 *RST: 1

Example:

SOUR:BB:STER:GRPS:CMNS:PTY 4
 sets the PTY number

[:SOURce<hw>]:BB:STEReo:GRPS:CMNS:TP <Tp>

Enables/disables the traffic program.

Parameters:

<Tp> 0|1|OFF|ON
 *RST: OFF

Example:

SOUR:BB:STER:GRPS:CMNS:TP ON
 enables sending of TP.

[:SOURce<hw>]:BB:STEReo:GRPS:GT<st0>:ABFLag <Abflag>

Sets the A/B Flag to 0 (disabled parameter) or 1 (enabled parameter).

Parameters:

<Abflag> 0|1|OFF|ON
 *RST: OFF

Example:

SOUR:BB:STER:GRPS:GT10:ABFL ON
 sets the A/B Flag for group type 10 to 1.

[:SOURce<hw>]:BB:STEReo:GRPS:GT<st0>:AFON:DATA<ch0> <Data>

Sets the alternative frequency (AF) for other networks.

This command is enabled only for group type 14A.

Suffix:

<st0> 14
 <ch0> 0 .. 24

Parameters:

<Data> float
 Range: 87.6 to 109.9
 *RST: 87.6

Example: `SOUR:BB:STER:GRPS:GT14:AFON:NOEN 10`
 enables using of 10 AFs.
 `SOUR:BB:STER:GRPS:GT14:AFON:DATA3 108.5`
 sets the alternative frequency at index 3 to 108.5 MHz

[:SOURce<hw>]:BB:STEReo:GRPS:GT<st0>:AFON:NOENtries <Noentries>

Sets the number of alternative frequency of other networks to be configured. A maximal number of 25 AFs can be configured.

This command is enabled only for group type 14A.

Suffix:
 <st0> 14

Parameters:
 <Noentries> float
 Range: 0 to 24
 *RST: 0

Example: `SOUR:BB:STER:GRPS:GT14:AFON:NOEN 10`
 enables using of 10 AFs.

[:SOURce<hw>]:BB:STEReo:GRPS:GT<st0>:AFON:STATe <State>

Enables/disables using AF method A for other networks.

This command is enabled only for group type 14A.

Suffix:
 <st0> 14

Parameters:
 <State> 0|1|OFF|ON
 *RST: OFF

Example: `SOUR:BB:STER:GRPS:GT14:AFON:STAT ON`
 enables using of Alternative Frequency (ON)

[:SOURce<hw>]:BB:STEReo:GRPS:GT<st0>:ALTF:DATA<ch0> <Data>

Sets the alternative frequency (AF) for the broadcast frequency.

This command is enabled only for group type 0A.

Suffix:

<st0> 0

<ch0> 0 .. 24

Parameters:

<Data> float

Range: 87.6 to 109.9

*RST: 87.6

Example:

SOUR:BB:STER:GRPS:GT0:ALTF:NOEN 10

enables using of 10 AFs.

SOUR:BB:STER:GRPS:GT0:ALTF:DATA3 108.5

sets the alternative frequency at index 3 to 108.5 MHz

[:SOURce<hw>]:BB:STEReo:GRPS:GT<st0>:ALTF:NOENtries <Noentries>

Sets the number of alternative frequency to be configured. A maximal number of 25 AFs can be configured.

This command is enabled only for group type 0A.

Suffix:

<st0> 0

Parameters:

<Noentries> float

Range: 0 to 24

*RST: 0

Example:

SOUR:BB:STER:GRPS:GT0:ALTF:NOEN 10

enables using of 10 AFs.

[:SOURce<hw>]:BB:STEReo:GRPS:GT<st0>:DATE <Date>

Sets the date type to user date (USRDate) or system date (SYSDate).

This command is enabled only for group type 4A.

Suffix:

<st0> 4

Parameters:

<Date> SYSDate|USRDate

*RST: SYSDate

Example: SOUR:BB:STER:GRPS:GT4:DATE USRD
selects user date

[:SOURce<hw>]:BB:STEReo:GRPS:GT<st0>:DID:ARTHead <Arthead>

Enables/disables using of Artificial Head.

Parameters:
<Arthead> 0|1|OFF|ON
*RST: OFF

Example: SOUR:BB:STER:GRPS:GT0:DID:ARTH ON
enables artificial head

[:SOURce<hw>]:BB:STEReo:GRPS:GT<st0>:DID:COMPressed <Compressed>

Enables/disables the compressed bit of DI.

Parameters:
<Compressed> 0|1|OFF|ON
*RST: OFF

Example: SOUR:BB:STER:GRPS:GT0:DID:COMP ON
enables the compressed bit

[:SOURce<hw>]:BB:STEReo:GRPS:GT<st0>:DID:DATA? <Data>

Queries the current decoder operating mode (mono, stereo, rtc.) as selected for group type 0.

This command is enabled only for group type 0 and 15B.

Suffix:
<st0> 0 |15

Parameters:
<Data> float
Range: 0 to 15
*RST: 0

Example: SOUR:BB:STER:GRPS:GT15:DID:DATA?
queries the DI
Response: 0101

Usage: Query only

[:SOURce<hw>]:BB:STEReo:GRPS:GT<st0>:DID:DPTY <Dpty>

Enables/disables dynamically PTY switching.

Parameters:

<Dpty> 0|1|OFF|ON
 *RST: OFF

Example: SOUR:BB:STER:GRPS:GT0:DID:DPTY OFF
 disables dynamic PTY

[:SOURce<hw>]:BB:STEReo:GRPS:GT<st0>:DID:STEReo <Stereo>

Sets the mono/stereo switch in the DI.

Parameters:

<Stereo> 0|1|OFF|ON
 *RST: OFF

Example: SOUR:BB:STER:GRPS:GT0:DID:STER OFF
 sets the DI bit to mono

[:SOURce<hw>]:BB:STEReo:GRPS:GT<st0>:INPMethod <Inpmethod>

Selects the input format of the RDS/RBDS parameters.

Suffix:

<st0> 0 .. 15

Parameters:

<Inpmethod> PARameters|UDMessage
PARameters
 Configuration based on direct parameter input
UDMessage
 User defined messages are used to configure the group types
 *RST: PAR

Example: SOUR:BB:STER:GRPS:GT:INPM UDM
 used defined message is used.

[:SOURce<hw>]:BB:STEReo:GRPS:GT<st0>:LION:EG <Eg>

Enables/disables the Extended Generic Indicator EG.

This command is enabled only for group type 14A.

Suffix:
<st0> 14

Parameters:
<Eg> 0|1|OFF|ON
*RST: OFF

Example: SOUR:BB:STER:GRPS:GT14:LION:EG ON
enables the Extended Generic Indicator EG

[:SOURce<hw>]:BB:STEReo:GRPS:GT<st0>:LION:ILS <lls>

Enables/disables the International Linkage Set indicator ILS.

This command is enabled only for group type 14A.

Suffix:
<st0> 14

Parameters:
<lls> 0|1|OFF|ON
*RST: OFF

Example: SOUR:BB:STER:GRPS:GT14:LION:ILS ON
enables ILS. i.e. sets ILS=1

[:SOURce<hw>]:BB:STEReo:GRPS:GT<st0>:LION:LA <La>

Enables/disables the Linkage Actuator LA.

This command is enabled only for group type 14A.

Suffix:
<st0> 14

Parameters:
<La> 0|1|OFF|ON
*RST: OFF

Example: SOUR:BB:STER:GRPS:GT14:LION:LA ON
enables LA, i.e. LA=1

[:SOURce<hw>]:BB:STEReo:GRPS:GT<st0>:LION:LSN <Lsn>

Sets the Linkage Set Number LSN.

The LSN is a 12 bit number.

This command is enabled only for group type 14A.

Suffix:

<st0> 14

Parameters:

<Lsn> integer

Range: 000 to FFF

*RST: 000

Example:

SOUR:BB:STER:GRPS:GT14:LION:LSN #H78
sets the LSN to #H78

[:SOURCE<hw>]:BB:STEReo:GRPS:GT<st0>:LION:STATe <State>

Enables/disables using of Linkage Information.

This command is enabled only for group type 14A.

Suffix:

<st0> 14

Parameters:

<State> 0|1|OFF|ON

*RST: OFF

Example:

SOUR:BB:STER:GRPS:GT14:LION:STAT ON
enables using of Linking Information

[:SOURCE<hw>]:BB:STEReo:GRPS:GT<st0>:LOTime <Lotime>

Sets the local offset time expressed in multiples of half hours within the range -12h to +12h.

The time is the sum of the user time and the local time offset.

This command is enabled only for group type 4A.

Suffix:

<st0> 4

Parameters:

<Lotime> string

Range: -12,00 to 12,00

*RST: 0:00

Example: SOUR:BB:STER:GRPS:GT4:TIME USRT
enables user time
SOUR:BB:STER:GRPS:GT4:USRT 12,15
sets the user time
SOUR:BB:STER:GRPS:GT4:LOT 5,30
sets the local offset time, i.e. the local time is 17:45

[:SOURce<hw>]:BB:STEReo:GRPS:GT<st0>:MFL:DATA<ch0>:MF <Mf>

Sets a mapped frequency entry.

Sets a mapped frequency entry. The following variant codes will be used to encode the frequency settings:

- Variant Code 5 (binary 0101) Mapped FM frequency 1 (ON)
- Variant Code 6 (binary 0110) Mapped FM frequency 2(ON)
- Variant Code 7 (binary 0111) Mapped FM frequency 3(ON)
- Variant Code 8 (binary 1000) Mapped FM frequency 4(ON)
- Variant Code 9 (binary 1001) Mapped AM frequency(ON)

This command is enabled only for group type 14A.

Suffix:

<st0> 14

<ch0> 0 .. 4

Parameters:

<Mf> 87.6 .. 107.9 MHz (Data 0..3) or 153 .. 279 kHz/531 .. 1602 kHz (Data 4)

Example: BB:STER:GRPS:GT14:MFL:MF2 101.3
sets the mapped frequency at index 2 to 101.3MHz.
BB:STER:GRPS:GT14:MFL:MF4 532
sets the mapped frequency at index 4 to 532 kHz.

[:SOURce<hw>]:BB:STEReo:GRPS:GT<st0>:MFL:DATA<ch0>:TF <Tf>

Sets a tuning frequency entry.

The following variant codes will be used to encode the frequency settings:

- Variant Code 5 (binary 0101) Tuning FM frequency 1 (ON)
- Variant Code 6 (binary 0110) Tuning FM frequency 2 (ON)
- Variant Code 7 (binary 0111) Tuning FM frequency 3 (ON)
- Variant Code 8 (binary 1000) Tuning FM frequency 4 (ON)
- Variant Code 9 (binary 1001) Tuning AM frequency (ON)

This command is enabled only for group type 14A.

Suffix:

<st0> 14

<ch0> 0 .. 4

Parameters:

<Tf> 87.6 .. 107.9 MHz (Data 0..3) or 153 .. 279 kHz/531 .. 1602 kHz (Data 4)

Example:

BB:STER:GRPS:GT14:MFL:TF2 87.7
sets the tuning frequency at index 2 to 87.7 MHz.

[:SOURce<hw>]:BB:STEReo:GRPS:GT<st0>:MFL:NOENtries <Noentries>

Sets the number of mapped frequency to be configured. A maximal number of 5 frequencies can be configured.

This command is enabled only for group type 14A.

Suffix:

<st0> 14

Parameters:

<Noentries> float

Range: 0 to 4

*RST: 0

Example:

SOUR:BB:STER:GRPS:GT14:MFL:NOEN 3
sets 3 mapped frequencies

[:SOURce<hw>]:BB:STEReo:GRPS:GT<st0>:MFL:STATe <State>

Enables/disables using of mapped frequencies.

This command is enabled only for group type 14A.

Suffix:

<st0> 14

Parameters:

<State> 0|1|OFF|ON

*RST: 0

Example: SOUR:BB:STER:GRPS:GT14:MFL:STAT ON
enables using of mapped sequences

[:SOURce<hw>]:BB:STEReo:GRPS:GT<st0>:MVSWitch <Mvswitch>

For GT0, enables switching between speech and music transmission.

For GT15B, this command is query only.

Suffix:
<st0> 0 | 15

Parameters:
<Mvswitch> MUSic|VOICe
*RST: MUSic

Example: SOUR:BB:STER:GRPS:GT0:MVSW VOIC
enables voice transmission
SOUR:BB:STER:GRPS:GT15:MVSW?
queries the state of Music/Voice parameter
Response: Voice

[:SOURce<hw>]:BB:STEReo:GRPS:GT<st0>:PINon:PIN <Pin>

Enters the program item number (PIN) of other networks.

This command is enabled only for group type 14A.

Suffix:
<st0> 14

Parameters:
<Pin> integer
Range: 0000 to FFFF
*RST: 0000

Example: SOUR:BB:STER:GRPS:GT14:PIN:STAT ON
enables using of PIN (ON)
SOUR:BB:STER:GRPS:GT14:PIN:PIN #H2AB3
sets the PIN of other networks

[:SOURce<hw>]:BB:STEReo:GRPS:GT<st0>:PINon:STATE <State>

Enables/disables using of PIN (ON).

This command is enabled only for group type 14A.

Suffix:

<st0> 14

Parameters:

<State> 0|1|OFF|ON

*RST: OFF

Example:

SOUR:BB:STER:GRPS:GT14:PIN:STAT ON
enables using of PIN (ON)

[:SOURCE<hw>]:BB:STEReo:GRPS:GT<st0>:PION <Pion>

Sets the parameter Program Identification of other networks in hex format.

This command is enabled only for group type 14A.

Suffix:

<st0> 14

Parameters:

<Pion> integer

Range: #H0000 to #HFFFF

*RST: #HD238

Example:

SOUR:BB:STER:GRPS:GT14:PION #H2D3A
sets the PI (ON)

[:SOURCE<hw>]:BB:STEReo:GRPS:GT<st0>:PSName <Pcname>

Enters the program service (PS) name.

The default maximum length of PS is 8 characters.

Suffix:

<st0> 0

Parameters:

<Pcname> string

*RST: SMU-FM

Example:

SOUR:BB:STER:GRPS:GT0:PSN 'Program 1'
sets the PS name.

[:SOURce<hw>]:BB:STEReo:GRPS:GT<st0>:PSON:PSName <Pname>

Enters the program service name (max 8 characters) of other networks.

This command is enabled only for group type 14A.

Suffix:

<st0> 14

Parameters:

<Pname> string

*RST: SMU-FM2

Example:

SOUR:BB:STER:GRPS:GT14:PSON:STAT ON

enables using of program service name (ON).

SOUR:BB:STER:GRPS:GT14:PSON:PSN 'PrServ1'

sets the program service name (ON)

[:SOURce<hw>]:BB:STEReo:GRPS:GT<st0>:PSON:STATe <State>

Enables/disables sending of program service name of other networks PS (ON).

This command is enabled only for group type 14A.

Suffix:

<st0> 14

Parameters:

<State> 0|1|OFF|ON

*RST: OFF

Example:

SOUR:BB:STER:GRPS:GT14:PSON:STAT ON

enables using of program service name (ON).

[:SOURce<hw>]:BB:STEReo:GRPS:GT<st0>:PTName <Pname>

Enters the program type name (max 8 characters).

This command is enabled only for group type 10A.

Suffix:

<st0> 10

Parameters:

<Pname> <Program Type Name>

*RST: Music

Example: `SOUR:BB:STER:GRPS:GT10:PTN 'Music Only'`
enters the program type name

[:SOURce<hw>]:BB:STEReo:GRPS:GT<st0>:PTYTa:PTY <Pty>

Sets the program type number of other networks.

This command is enabled only for group type 14A.

Suffix:
<st0> 14

Parameters:
<Pty> float

Range: 1 to 31
*RST: 1

Example: `SOUR:BB:STER:GRPS:GT14:PTYT:STAT ON`
enables PTY/TA of other networks
`SOUR:BB:STER:GRPS:GT14:PTYT:PTY 15`
sets the program type (ON)

[:SOURce<hw>]:BB:STEReo:GRPS:GT<st0>:PTYTa:STATE <State>

Enables/disables using of PTY (ON) and TA (ON).

This command is enabled only for group type 14A.

Suffix:
<st0> 14

Parameters:
<State> 0|1|OFF|ON

*RST: OFF

Example: `SOUR:BB:STER:GRPS:GT14:PTYT:STAT ON`
enables PTY/TA of other networks

[:SOURce<hw>]:BB:STEReo:GRPS:GT<st0>:PTYTa:TA <Ta>

Enables/disables the traffic announcement (TA) of other networks.

This command is enabled only for group type 14A.

Suffix:

<st0> 14

Parameters:

<Ta> 0|1|OFF|ON

*RST: OFF

Example:

SOUR:BB:STER:GRPS:GT14:PTYT:STAT ON
enables PTY/TA of other networks

SOUR:BB:STER:GRPS:GT14:PTYT:TAON ON
enables traffic communication (ON)

[:SOURce<hw>]:BB:STEReo:GRPS:GT<st0>:RADText <Radtext>

Sets the radio text.

This command is enabled only for group type 2.

Suffix:

<st0> 2

Parameters:

<Radtext> string

*RST: SMU-Radio

Example:

SOUR:BB:STER:GRPS:GT2:RADT 'RADIO MESSAGE'
sets the radio text

[:SOURce<hw>]:BB:STEReo:GRPS:GT<st0>:STATE <State>

Enables/disables the transmission of the corresponding group type.

Suffix:

<st0> 0 .. 15

Parameters:

<State> 0|1|OFF|ON

*RST: ON

Example:

SOUR:BB:STER:GRPS:GT12:STAT ON
group 12 will be transmitted

[:SOURce<hw>]:BB:STEReo:GRPS:GT<st0>:SYSDate <Sysdate>

Queries the system date.

This command is enabled only for group type 4A.

Suffix:

<st0> 14

Parameters:

<Sysdate> string

Range: 01,01,2006 to 31,12,9999

Example:

```
SOUR:BB:STER:GRPS:GT4:DATE SYSD
selects system date
SOUR:BB:STER:GRPS:GT4:SYSD?
queries the system date
Response: 3,6,2008
```

[:SOURce<hw>]:BB:STEReo:GRPS:GT<st0>:SYSTime <Systemtime>

Queries the system time.

This command is enabled only for group type 4A.

Suffix:

<st0> 4

Parameters:

<Systemtime> string

Range: 00,00 to 23,59

Example:

```
SOUR:BB:STER:GRPS:GT4:TIME SYSD
selects system date
SOUR:BB:STER:GRPS:GT4:SYST?
queries the system time
```

[:SOURce<hw>]:BB:STEReo:GRPS:GT<st0>:TA <Ta>

Enables/disables broadcasting of traffic announcement.

Parameters:

<Ta> 0|1|OFF|ON

*RST: OFF

Example:

```
SOUR:BB:STER:GRPS:GT0:TA ON
enables TA for group type 0
```

[:SOURce<hw>]:BB:STEReo:GRPS:GT<st0>:TABFlag <Tabflag>

Sets the Text A/B Flag to 0 (disabled parameter) or 1 (enabled parameter).

Parameters:

<Tabflag> 0|1|OFF|ON

*RST: OFF

Example:

SOUR:BB:STER:GRPS:GT2:TABF ON
sets the Text A/B Flag for group type 2 to 1.

[:SOURce<hw>]:BB:STEReo:GRPS:GT<st0>:TAON <Taon>

Enables/disables the traffic announcement (TA) of other networks.

This command is enabled only for group type 14B.

Suffix:

<st0> 14

Parameters:

<Taon> 0|1|OFF|ON

*RST: OFF

Example:

SOUR:BB:STER:GRPS:GT14:TAON ON
enables TA (ON)

[:SOURce<hw>]:BB:STEReo:GRPS:GT<st0>:TIME <Time>

Sets the time type to system time (SYSTime) or user time (USRTTime).

This command is enabled only for group type 4A.

Suffix:

<st0> 4

Parameters:

<Time> SYSTime|USRTTime

*RST: SYSTime

Example:

SOUR:BB:STER:GRPS:GT4:TIME USRT
selects user time

[:SOURce<hw>]:BB:STEReo:GRPS:GT<st0>:TPON <Tpon>

Enables/ disables the traffic program of other networks.

Parameters:

<Tpon> 0|1|OFF|ON
 *RST: OFF

Example:

SOUR:BB:STER:GRPS:GT14:TPON ON
 enables traffic program (ON)

[:SOURce<hw>]:BB:STEReo:GRPS:GT<st0>:TTIME <Ttime>

Sets the group transmit time. The transmit time is the group repetition rate given as proportion. The sum of all transmit time is 100%.

Only groups with "State" set to On ([:SOURce<hw>]:BB:STEReo:GRPS:GT<st0>:STATE) are transmitted.

Suffix:

<st0> 0 .. 15

Parameters:

<Ttime> float
 Range: 0 to 100
 *RST: 40% (GT0), 10% (GT1), 15% (GT2), 4% (GT3), 2% (GT4..GT13), 10% (GT14), 1% (GT15)

Example:

SOUR:BB:STER:GRPS:GT12:STAT ON
 group 12 will be transmitted
 SOUR:BB:STER:GRPS:GT12:TTIM 6
 the transmission time of group 12 is 6%

**[:SOURce<hw>]:BB:STEReo:GRPS:GT<st0>:UMT:DATA<ch0>:BLOCK<user>
 <Block>**

Sets the hex value for the corresponding block of the corresponding user message hex table row.

Checksum and offset are automatically calculated.

Suffix:

<st0> 0 .. 25

<ch0> 0 .. 31

<user> 2 .. 4

Parameters:

<Block> float

Range: #H00(Block 2), #H0000 (Block 3&4) to #H1F(Block 2), #HFFFF (Block 3&4)

*RST: #H00 (Block 2), #H0000 (Block 3, Block4)

Example:

SOUR:BB:STER:GRPS:GT0:UMT:DATA0:BLOCK2 #H1F
sets block 2 to 1F

[:SOURce<hw>]:BB:STEReo:GRPS:GT<st0>:UMT:NOENtries <Noentries>

Sets the number of transmitted groups per message. A maximal number of 32 groups can be configured.

Suffix:

<st0> 0 .. 15

Parameters:

<Noentries> float

Range: 0 to 31

*RST: 0

Example:

SOUR:BB:STER:GRPS:GT0:UMT:NOEN 4
4 user defined messages will be used

[:SOURce<hw>]:BB:STEReo:GRPS:GT<st0>:USRDate <Usrdate>

Sets the user date in format DD,MM,YYYY.

This command is enabled only for group type 4A.

Suffix:

<st0> 4

Parameters:

<Usrdate> DD,MM,YYYY

Range: 01,01,2006 to 31,12,9999

*RST: 01,01,2006

Example:

SOUR:BB:STER:GRPS:GT4:DATE USRD
selects user date
SOUR:BB:STER:GRPS:GT4:USRD '30,05,2008'
sets the user date

[:SOURce<hw>]:BB:STEReo:GRPS:GT<st0>:USRTTime <Usrtime>

Sets the user time in format HH,MM. The time is the sum of the user time and the local time offset (`[:SOURce<hw>]:BB:STEReo:GRPS:GT<st0>:LOTime`).

This command is enabled only for group type 4A.

Suffix:

<st0> 4

Parameters:

<Usrtime> string
 Range: 00,00 to 23,59
 *RST: 00,00

Example:

```
SOUR:BB:STER:GRPS:GT4:TIME USRT
selects user time
SOUR:BB:STER:GRPS:GT4:USRT 12,15
sets the user time
```

[:SOURce<hw>]:BB:STEReo:GRPS:GT<st0>:VERSion <Version>

Sets the group type version of the corresponding group type.

Suffix:

<st0> 0 .. 15

Parameters:

<Version> A|B
A
 Group Type Version A
B
 Group Type Version B
 *RST: A

Example:

```
SOUR:BB:STER:GRPS:GT2:VERS B
sets group type 2 with version B
```

[:SOURce<hw>]:BB:STEReo:GRPS:PRESet

Sets all group parameter values to the default settings.

Example:

```
SOUR:BB:STER:GRPS:PRES
presets all groups
```

Usage:

Event

[:SOURCE<hw>]:BB:STEReo:GRPS:STORE <Store>

Stores the current RDS/RBDS group settings into the selected file. The directory is set using command `MMEM:CDIRectory`. A path can also be specified, in which case the files in the specified directory are read. Only the file name has to be entered. RDS/RBDS group settings are stored as files with the specific file extension `*.fm_gt`.

Parameters:

<Store> string

Example:

`SOUR:BB:STER:GRPS:STOR 'fm_groups'`
saves the RDS/RBDS setting into the file `fm_groups.fm_gt`

Usage:

Setting only

List of Commands

[:SOURCE<hw>]:BB:STEReo:AUDio:CATalog.....	46
[:SOURCE<hw>]:BB:STEReo:AUDio:DSElect.....	47
[:SOURCE<hw>]:BB:STEReo:AUDio:EXTClock.....	47
[:SOURCE<hw>]:BB:STEReo:AUDio:LEVel.....	47
[:SOURCE<hw>]:BB:STEReo:AUDio:MODE.....	48
[:SOURCE<hw>]:BB:STEReo:AUDio:PREemphasis.....	48
[:SOURCE<hw>]:BB:STEReo:AUDio[:FREQuency].....	48
[:SOURCE<hw>]:BB:STEReo:DEVIation.....	45
[:SOURCE<hw>]:BB:STEReo:DS:CATalog.....	51
[:SOURCE<hw>]:BB:STEReo:DS:DEVIation.....	51
[:SOURCE<hw>]:BB:STEReo:DS:DRATE.....	52
[:SOURCE<hw>]:BB:STEReo:DS:DSElect.....	52
[:SOURCE<hw>]:BB:STEReo:DS:DSET.....	52
[:SOURCE<hw>]:BB:STEReo:DS:GIM.....	53
[:SOURCE<hw>]:BB:STEReo:DS:MODE.....	53
[:SOURCE<hw>]:BB:STEReo:DS:PHAsE.....	53
[:SOURCE<hw>]:BB:STEReo:DS:STATe.....	53
[:SOURCE<hw>]:BB:STEReo:GHEX:CATalog.....	54
[:SOURCE<hw>]:BB:STEReo:GHEX:DATA<ch0>:BLOCk<st>.....	54
[:SOURCE<hw>]:BB:STEReo:GHEX:LOAD.....	55
[:SOURCE<hw>]:BB:STEReo:GHEX:NOENtries.....	55
[:SOURCE<hw>]:BB:STEReo:GHEX:PRESet.....	55
[:SOURCE<hw>]:BB:STEReo:GHEX:STORe.....	56
[:SOURCE<hw>]:BB:STEReo:GRPS:AGPReset.....	57
[:SOURCE<hw>]:BB:STEReo:GRPS:CMNS:PI.....	57
[:SOURCE<hw>]:BB:STEReo:GRPS:CMNS:PTY.....	57
[:SOURCE<hw>]:BB:STEReo:GRPS:CMNS:TP.....	58
[:SOURCE<hw>]:BB:STEReo:GRPS:GT<st0>:ABFLag.....	58
[:SOURCE<hw>]:BB:STEReo:GRPS:GT<st0>:AFON:DATA<ch0>.....	58
[:SOURCE<hw>]:BB:STEReo:GRPS:GT<st0>:AFON:NOENtries.....	59
[:SOURCE<hw>]:BB:STEReo:GRPS:GT<st0>:AFON:STATe.....	59
[:SOURCE<hw>]:BB:STEReo:GRPS:GT<st0>:ALTF:DATA<ch0>.....	59
[:SOURCE<hw>]:BB:STEReo:GRPS:GT<st0>:ALTF:NOENtries.....	60
[:SOURCE<hw>]:BB:STEReo:GRPS:GT<st0>:DATE.....	60
[:SOURCE<hw>]:BB:STEReo:GRPS:GT<st0>:DID:ARTHAd.....	61
[:SOURCE<hw>]:BB:STEReo:GRPS:GT<st0>:DID:COMPResseD.....	61
[:SOURCE<hw>]:BB:STEReo:GRPS:GT<st0>:DID:DATA.....	61
[:SOURCE<hw>]:BB:STEReo:GRPS:GT<st0>:DID:DPTY.....	62
[:SOURCE<hw>]:BB:STEReo:GRPS:GT<st0>:DID:STEReo.....	62
[:SOURCE<hw>]:BB:STEReo:GRPS:GT<st0>:INPMethod.....	62
[:SOURCE<hw>]:BB:STEReo:GRPS:GT<st0>:LION:EG.....	62
[:SOURCE<hw>]:BB:STEReo:GRPS:GT<st0>:LION:ILS.....	63
[:SOURCE<hw>]:BB:STEReo:GRPS:GT<st0>:LION:LA.....	63
[:SOURCE<hw>]:BB:STEReo:GRPS:GT<st0>:LION:LSN.....	63
[:SOURCE<hw>]:BB:STEReo:GRPS:GT<st0>:LION:STATe.....	64
[:SOURCE<hw>]:BB:STEReo:GRPS:GT<st0>:LOTIme.....	64
[:SOURCE<hw>]:BB:STEReo:GRPS:GT<st0>:MFL:DATA<ch0>:MF.....	65

[:SOURCE<hw>]:BB:STEReo:GRPS:GT<st0>:MFL:DATA<ch0>:TF.....	65
[:SOURCE<hw>]:BB:STEReo:GRPS:GT<st0>:MFL:NOENtries.....	66
[:SOURCE<hw>]:BB:STEReo:GRPS:GT<st0>:MFL:STATe.....	66
[:SOURCE<hw>]:BB:STEReo:GRPS:GT<st0>:MVSWitch.....	67
[:SOURCE<hw>]:BB:STEReo:GRPS:GT<st0>:PINon:PIN.....	67
[:SOURCE<hw>]:BB:STEReo:GRPS:GT<st0>:PINon:STATe.....	67
[:SOURCE<hw>]:BB:STEReo:GRPS:GT<st0>:PION.....	68
[:SOURCE<hw>]:BB:STEReo:GRPS:GT<st0>:PSName.....	68
[:SOURCE<hw>]:BB:STEReo:GRPS:GT<st0>:PSON:PSName.....	69
[:SOURCE<hw>]:BB:STEReo:GRPS:GT<st0>:PSON:STATe.....	69
[:SOURCE<hw>]:BB:STEReo:GRPS:GT<st0>:PTName.....	69
[:SOURCE<hw>]:BB:STEReo:GRPS:GT<st0>:PTYTa:PTY.....	70
[:SOURCE<hw>]:BB:STEReo:GRPS:GT<st0>:PTYTa:STATe.....	70
[:SOURCE<hw>]:BB:STEReo:GRPS:GT<st0>:PTYTa:TA.....	70
[:SOURCE<hw>]:BB:STEReo:GRPS:GT<st0>:RADText.....	71
[:SOURCE<hw>]:BB:STEReo:GRPS:GT<st0>:STATe.....	71
[:SOURCE<hw>]:BB:STEReo:GRPS:GT<st0>:SYSDate.....	72
[:SOURCE<hw>]:BB:STEReo:GRPS:GT<st0>:SYSTime.....	72
[:SOURCE<hw>]:BB:STEReo:GRPS:GT<st0>:TA.....	72
[:SOURCE<hw>]:BB:STEReo:GRPS:GT<st0>:TABFlag.....	73
[:SOURCE<hw>]:BB:STEReo:GRPS:GT<st0>:TAON.....	73
[:SOURCE<hw>]:BB:STEReo:GRPS:GT<st0>:TIME.....	73
[:SOURCE<hw>]:BB:STEReo:GRPS:GT<st0>:TPON.....	73
[:SOURCE<hw>]:BB:STEReo:GRPS:GT<st0>:TTIme.....	74
[:SOURCE<hw>]:BB:STEReo:GRPS:GT<st0>:UMT:DATA<ch0>:BLOCk<user>.....	74
[:SOURCE<hw>]:BB:STEReo:GRPS:GT<st0>:UMT:NOENtries.....	75
[:SOURCE<hw>]:BB:STEReo:GRPS:GT<st0>:USRDate.....	75
[:SOURCE<hw>]:BB:STEReo:GRPS:GT<st0>:USRTime.....	76
[:SOURCE<hw>]:BB:STEReo:GRPS:GT<st0>:VERsion.....	76
[:SOURCE<hw>]:BB:STEReo:GRPS:PRESet.....	76
[:SOURCE<hw>]:BB:STEReo:GRPS:STORe.....	77
[:SOURCE<hw>]:BB:STEReo:PILot:PHASe.....	49
[:SOURCE<hw>]:BB:STEReo:PILot:STATe.....	49
[:SOURCE<hw>]:BB:STEReo:PILot[DEVIation].....	49
[:SOURCE<hw>]:BB:STEReo:PRESet.....	44
[:SOURCE<hw>]:BB:STEReo:PUWSint.....	50
[:SOURCE<hw>]:BB:STEReo:SETTing:CATalog.....	44
[:SOURCE<hw>]:BB:STEReo:SETTing:LOAD.....	45
[:SOURCE<hw>]:BB:STEReo:SETTing:STORe.....	45
[:SOURCE<hw>]:BB:STEReo:SOURce.....	46
[:SOURCE<hw>]:BB:STEReo:STATe.....	44
[:SOURCE<hw>]:BB:STEReo:TRIGger:RMODE.....	50
[:SOURCE<hw>]:BB:STEReo[TRIGger]:SEQUence.....	50

Index

A

Activate FM-STEREO Standard	13
Activate FM Stereo Standard	44
Alternative Frequency List	27
Alternative Frequency List (ON)	32
Artificial Head	28, 61
Audio Level	17, 47
Audio Mode	17
Audio Source	14, 46
Auto	50

B

Block	40
User Message Table	74
Block 2	39
Block 3	39
Block 4	39

C

Compressed PTY	28, 61
----------------------	--------

D

Data Rate	19
Data Set	19
RDS/RBDS	52
Date	30, 60, 72
Deactivate FM-STEREO Standard	13
Deactivate FM Stereo Standard	44
Decoder Identification	38, 61
Decoder Information	25, 28, 69
Default settings	44
Default Settings	13
Deviation	19
Pilot	49
RDS/RBDS	51
Do Conf	27
Documentation Overview	5
Dynamic PTY	28, 62

E

Edit User Group	20
Edit User Message Table	26
Extended Configuration	25
Extended Generic Indicator (EG)	37, 62
External Clock	16, 47

F

File Manger	13
FM Deviation	14, 45
Frequency	
Alternative Frequency List	29, 58, 59
Alternative Frequency List ON	35

G

Global Trigger/Clock Settings	42
Groups Input Mehtod	20, 53
Group Type	26

Group Type Number	26
Group Type Version	25

I

Input Method	24
International Linkage Set Indicator	37, 63

L

LF-Generator Frequency	16, 48
Linkage Actuator (LA)	36, 63
Linkage Set Number LSN	37, 63
Load Audio File	16
Load FM-STEREO Settings	13
Load Hex Data	40
Local Offset Time	30, 64

M

Mapped Frequency	36
Mapped Frequency (ON)	65
Mapped Frequency List	32
Marker	18
Mode	20
RDS/RBDS	53
Music/Voice Switch	28, 38, 67

N

No. of Message Entries	41
No. of Transmitted Groups	39
User Message Table	75
No. of Used Frequency	
Alternative Frequency List	29, 59, 60
Alternative Frequency List ON	35
Mapped Frequency List	35, 66

O

Open File Manager	13
-------------------------	----

P

Phase	19
Pilot	49
RDS/RBDS	53
Pilot Deviation	18
Pilot Phase	18
Pilot State	18
Preemphasis	17, 48
Preset Hex Table	40
Program Identification	21, 57
Program Identification (ON)	32, 68
Program Item Number (ON)	38, 67
Program Service Name	29, 68
Program Service Name (ON)	35, 69
Program Type	23
Program Type Number	22, 57
Program Type Number (ON)	37, 70

R

Radio Band	36
------------------	----

Radio Text	25, 58, 71, 73
RDS/RBDS ConfigurationEOEO	18
Recall Configuration	13
Recall FM-STEREO Settings	13
Running	42

S

Save Configuration	13
Save FM-STEREO Settings	13
Save Groups	21
Select Group List	20
Set Active Group to Default	57
Set Groups to Default	21, 76
Settings Update	18, 50
Set to default	44
Set to Default	13
Set to default Group Hex Table	55
Standard settings	44
Standard Settings	13
State	13, 19
AF method A	35, 59
FM Stereo Standard	44
Group Table	26, 71
Linkage Information	36, 64
Mapped Frequencies	35, 66
Pilot	49
PIN	37, 67
Program Service	34, 69
PTY/ TA	37, 70
RDS/RBDS	53
Stereo	29, 62
Stopped	42
System Date	30
System Time	30, 72

T

Time	30, 73
Traffic Announcement	28, 38, 72
Traffic Announcement (ON)	37, 70, 73
Traffic Program	23, 58
Traffic Program (ON)	33, 73
Transmit Time	26
Group Table	74
Trigger	18
Trigger Mode	50
Auto	42
Tuning Frequency	36
Tuning Frequency (ON)	65

U

User Date	30, 75
User Marker / AUX I/O Settings	42
User Time	30, 76

V

Version	
Group Type	76